

VELUX Modular Skylights

Technical Handbook

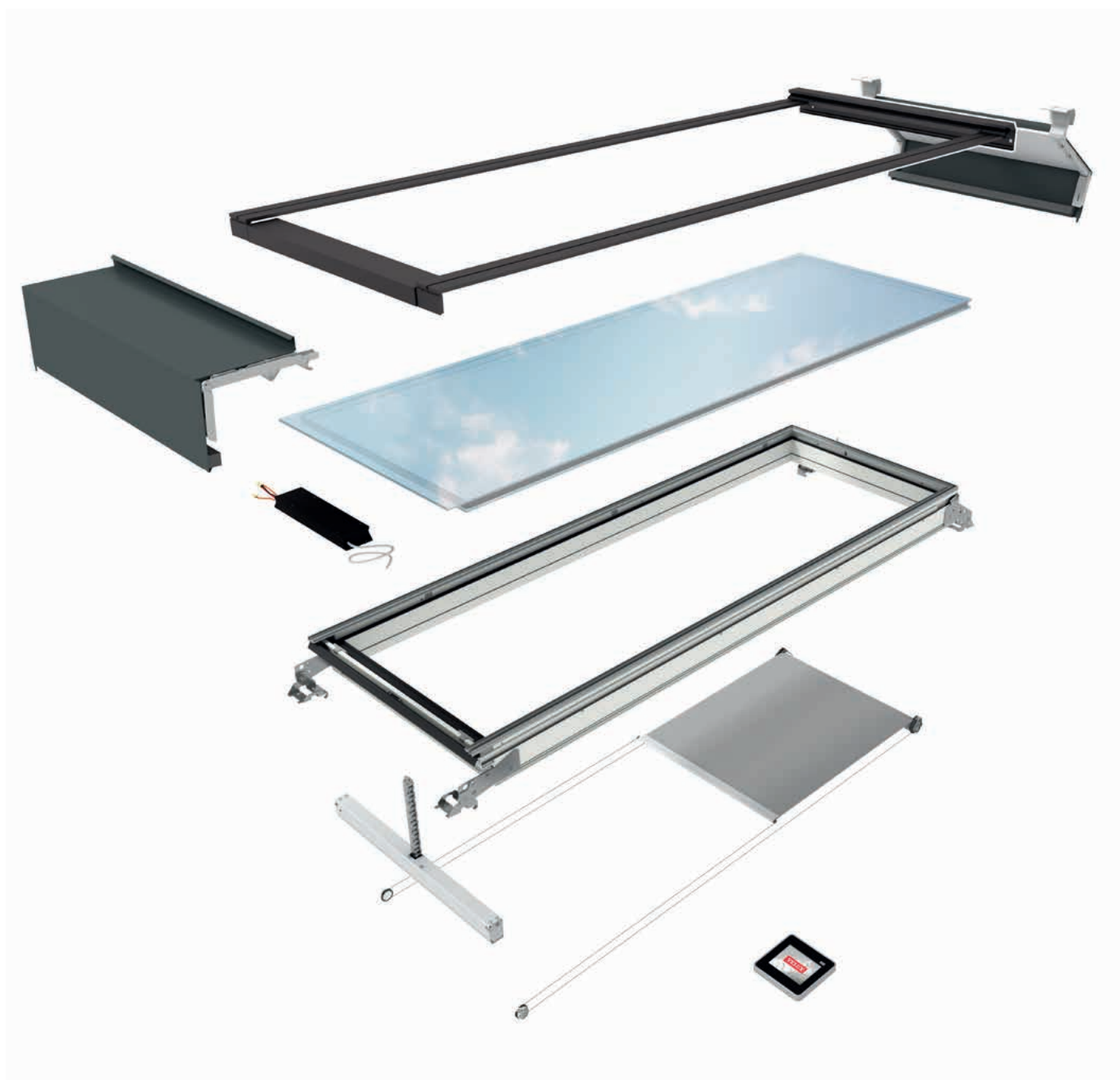



VELUX Modular Skylights

VELUX modular skylights are sash-frame constructed single skylights with a high-insulating glazing unit. The modules are available as fixed and venting skylights. All individual skylights are delivered as prefabricated modules with dedicated factory finished flashings to ensure watertightness in every available solution.

VELUX modular skylights are CE-marked in accordance with the harmonized standard EN 14351-1 – Windows and doors.

In addition the skylight modules have been tested and approved in accordance with EN 12101-2 – Smoke and heat control systems Part 2: Specification for natural smoke and heat exhaust ventilators.

This technical handbook for VELUX modular skylights describes the product characteristics and performance of the skylight module together with sunscreening and control system. For real life case studies and inspiration, please refer to velux.co.uk/modularskylights

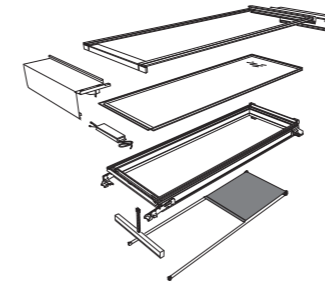

Modular System 7

- Skylight Module 8
- Functions & Sizes 8
- How to measure the modules 10
- Solutions 12
- Module – Main Components 14
- Module – Electrical Components 15
- Frame & Sash 16
- Cladding 20
- Flashing 21
- Glazing Unit 22
- Brackets & Hinges 24
- Module - Assembled 26
- Vapour Barrier Connection Strip 28
- Chain Actuator 29
- Control System 30
- Wind deflector for smoke ventilation modules 31
- Roller Blind 32
- Beam for Ridgelight at 5° 34
- Type Sign 35

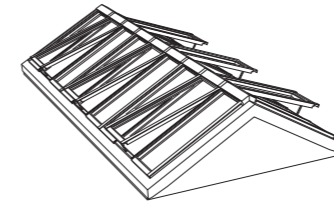

Solutions 37

- Quick Overview of Skylight Solutions vs. Roof Constructions 38
- Longlight 5 - 25° 40
- Wall-mounted Longlight 5 - 40° 42
- Northlight 25 - 90° 44
- Ridgelight 25 - 40° 46
- Ridgelight at 5° with Beam 48
- Atrium Longlight 50
- Atrium Ridgelight and Atrium Ridgelight at 5° with Beam 52

VELUX® Modular Skylight and Atrium Longlight and Atrium Ridgelight - 2024

Product	Accessories	Accessories	Accessories
Skylight Area	EN 12183 21000	Act 101	EN 12183 21000
Skylight Area	EN 12183 21000 Access 1	Act 101	EN 12183 21000
Skylight Area	EN 12183 21000 Access 2	Act 101	EN 12183 21000
Skylight Area	EN 12183 21000 Access 3	Act 101	EN 12183 21000
Skylight Area	EN 12183 21000 Access 4	Act 101	EN 12183 21000
Skylight Area	EN 12183 21000 Access 5	Act 101	EN 12183 21000
Skylight Area	EN 12183 21000 Access 6	Act 101	EN 12183 21000
Skylight Area	EN 12183 21000 Access 7	Act 101	EN 12183 21000
Skylight Area	EN 12183 21000 Access 8	Act 101	EN 12183 21000
Skylight Area	EN 12183 21000 Access 9	Act 101	EN 12183 21000
Skylight Area	EN 12183 21000 Access 10	Act 101	EN 12183 21000
Skylight Area	EN 12183 21000 Access 11	Act 101	EN 12183 21000
Skylight Area	EN 12183 21000 Access 12	Act 101	EN 12183 21000
Skylight Area	EN 12183 21000 Access 13	Act 101	EN 12183 21000
Skylight Area	EN 12183 21000 Access 14	Act 101	EN 12183 21000
Skylight Area	EN 12183 21000 Access 15	Act 101	EN 12183 21000
Skylight Area	EN 12183 21000 Access 16	Act 101	EN 12183 21000
Skylight Area	EN 12183 21000 Access 17	Act 101	EN 12183 21000
Skylight Area	EN 12183 21000 Access 18	Act 101	EN 12183 21000
Skylight Area	EN 12183 21000 Access 19	Act 101	EN 12183 21000
Skylight Area	EN 12183 21000 Access 20	Act 101	EN 12183 21000

Product Data 55

- Skylight Module 56
- Glazing Area 65
- Frame & Sash 65
- Cladding & Flashing 65
- Glazing Unit 66
- Vapour Barrier Connection Strip 68
- Chain Actuator 68
- Control System 70
- Roller Blind 71
- Beam for Ridgelight at 5° 75
- Resistance to Wind Load 76
- Reaction to Fire 78
- Resistance to Fire 80
- External Fire Performance 82
- Watertightness 84
- Air Permeability 86

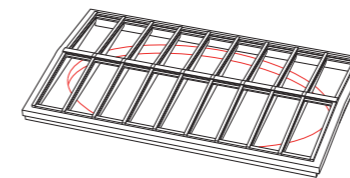

Additional Solutions 89

- Shaped Solution with Adaption of Lining 90
- Shaped Solutions with Oval Lining 90
- Asymmetric Ridgelight 91
- Asymmetric of combined solutions 91
- Infill Panel 92
- Skylight Modules with Photovoltaic Glazing Units 92
- Light fittings on modules 93

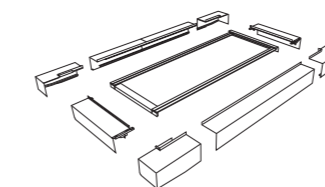

Product codes 95

- Modular Skylights 96
- Modular Flashings 97
- Roller Blinds 98
- Product Label 98

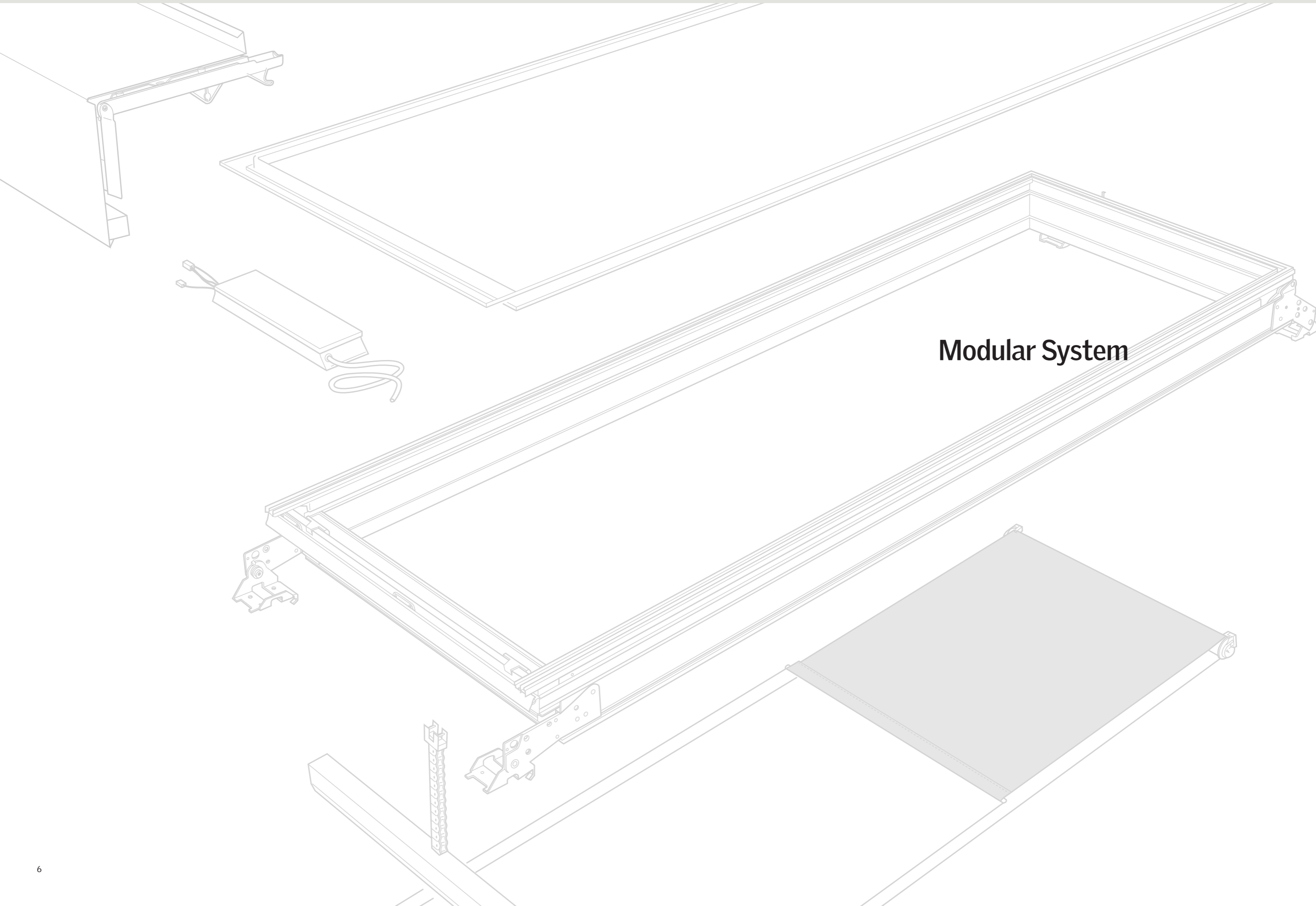

Modular System

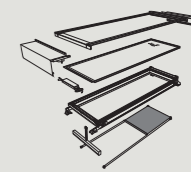

Skylight Module

CE marked VELUX modular skylights can be used in any building where the national, local and individual building requirements allow the use of skylight modules. Given the aesthetics and advanced performance of the products, VELUX modular skylights are commonly used in heated buildings and primarily in projects that support light

commercial interests, e.g. hospitals, schools, shopping centres, offices, museums etc. However all buildings that have a suitable structure, and which are large enough to host an installation, will support VELUX modular skylights.

Functions & Sizes

VELUX modular skylights are available as fixed and venting modules. Due to a hidden chain actuator, the fixed and venting skylight modules appear to be visually identical in closed position.

Venting modules are top-hung and can be used for comfort ventilation, and in addition, certain types are approved for smoke ventilation in accordance with EN 12101-2.



HFC
Fixed skylight module



HVC
Motorized comfort venting skylight module
Opening up to 410 mm



HVC
Motorized smoke venting skylight module
Opening up to 700 mm in less than 60 seconds

Size grid

Standard size. Special sizes, functional limitations may apply.

Fixed modules

mm	675	750	800	900	1000
800	Standard size	Standard size	Standard size	Standard size	Standard size
1000	Standard size	Standard size	Standard size	Standard size	Standard size
1200	Standard size	Standard size	Standard size	Standard size	Standard size
1400	Standard size	Standard size	Standard size	Standard size	Standard size
1600	Standard size	Standard size	Standard size	Standard size	Standard size
1800	Standard size	Standard size	Standard size	Standard size	Standard size
2000	Standard size	Standard size	Standard size	Standard size	Standard size
2200	Standard size	Standard size	Standard size	Standard size	Standard size
2400	Standard size	Standard size	Standard size	Standard size	Standard size
2600	* △	* △	* △	* △	* △
2800	* △	* △	* △	* △	* △
3000	* △	* △	* △	* △	* △

Comfort ventilation

mm	675	750	800	900	1000
800	○	○	○	○	○
1000	○	○	○	○	○
1200	Standard size	Standard size	Standard size	Standard size	Standard size
1400	Standard size	Standard size	Standard size	Standard size	Standard size
1600	Standard size	Standard size	Standard size	Standard size	Standard size
1800	Standard size	Standard size	Standard size	Standard size	Standard size
2000	Standard size	Standard size	Standard size	Standard size	Standard size
2200	Standard size	Standard size	Standard size	Standard size	Standard size
2400	Standard size	Standard size	Standard size	Standard size	Standard size
2600	* △	* △			
2800	* △				

Smoke ventilation

mm	675	750	800	900	1000
800	Standard size	Standard size	Standard size	Standard size	Standard size
1000	Standard size	Standard size	Standard size	Standard size	Standard size
1200	Standard size	Standard size	Standard size	Standard size	Standard size
1400	Standard size	Standard size	Standard size	Standard size	Standard size
1600	Standard size	Standard size	Standard size	Standard size	Standard size
1800	Standard size	Standard size	Standard size	Standard size	Standard size
2000	Standard size	Standard size	Standard size	Standard size	Standard size
2200	Standard size	Standard size	Standard size	Standard size	Standard size
2400	Standard size	Standard size	Standard size	Standard size	Standard size
2600	* △	* △			
2800	* △				

If roller blinds are requested for smoke venting modules, please refer to local fire authorities for permission.

- * Modules height above 2400 are delivered with extra strong glazing unit only.
- △ No roller blinds available.
- Only open system actuator available.

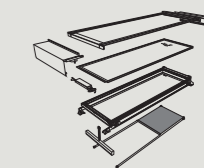

How to measure the modules

Width and height of the modules are determined by the exterior **W** and **H** dimensions of the frame – not the measurements of the cladding, flashing or brackets.

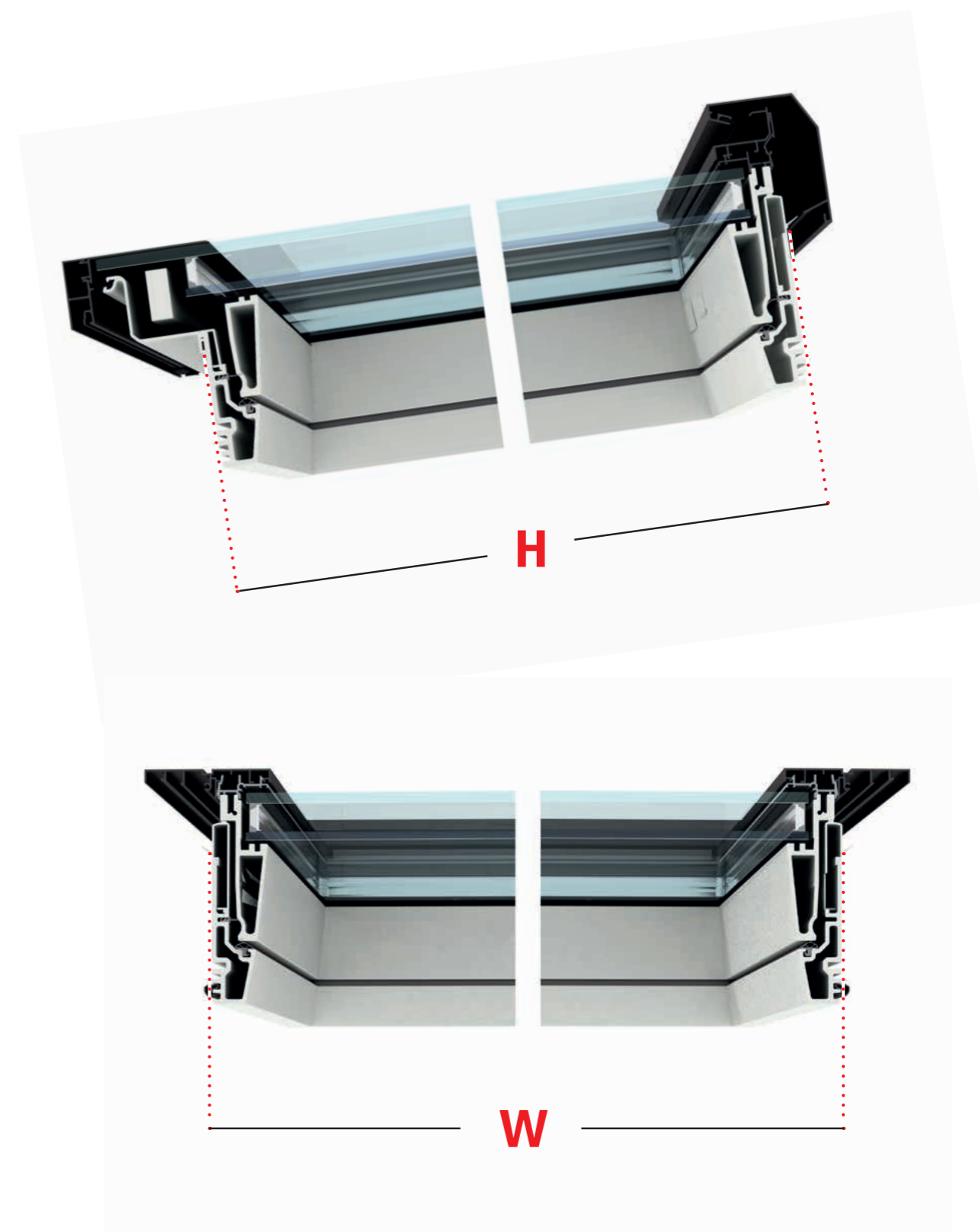

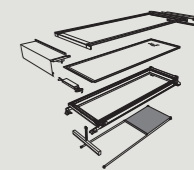

Solutions (monopitch)

VELUX modular skylights can be combined in a number of configurations creating perfect solutions for a wide variety of building types, from narrow corridors and internal courts to studios and

large circulation spaces. Each solution is delivered with a special designed, prefabricated flashing ensuring perfect system.

Longlight 5 - 25°

Page: 40

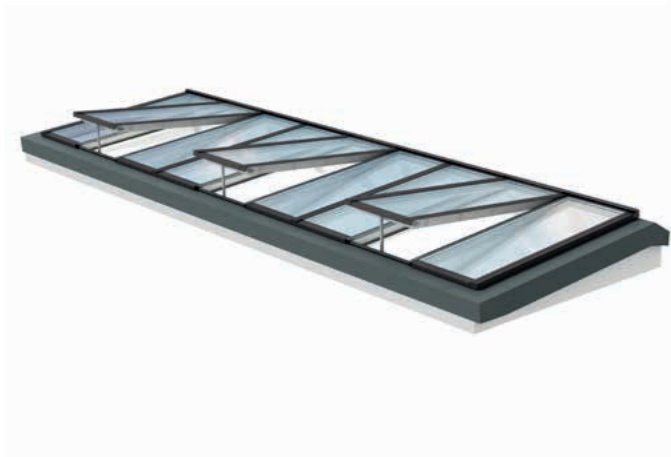

Wall-mounted Longlight 5 - 40°

Page: 42



Northlight 25 - 90°

Page: 44



Atrium Longlight 5 - 25°

Page: 48

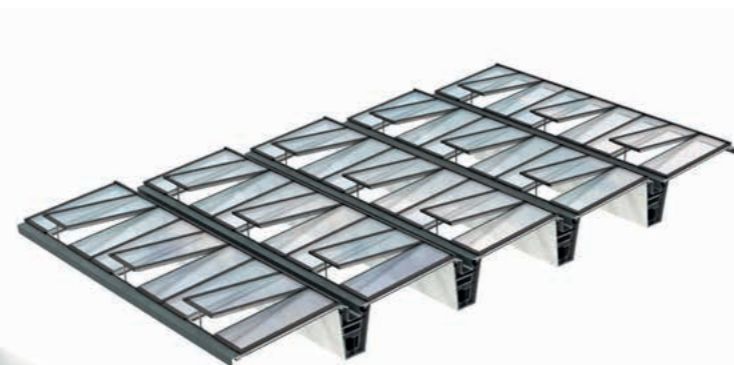

Ridgelight (dual pitch)

Ridgelight 25 - 40°

Page: 46



Ridgelight at 5° with Beam

Page: 48

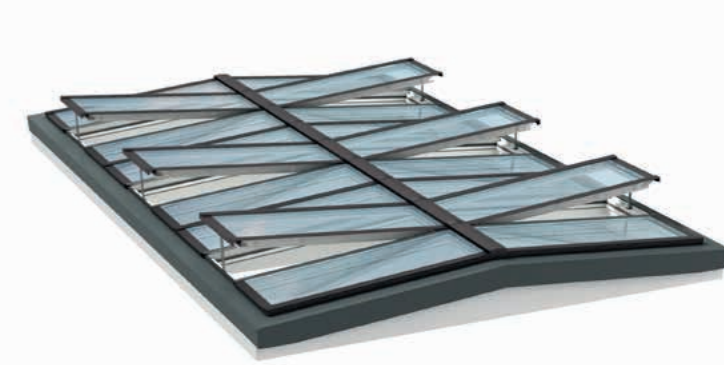

Atrium Ridgelight 25 - 40°

Page: 50



Atrium Ridgelight at 5° with Beam

Page: 52

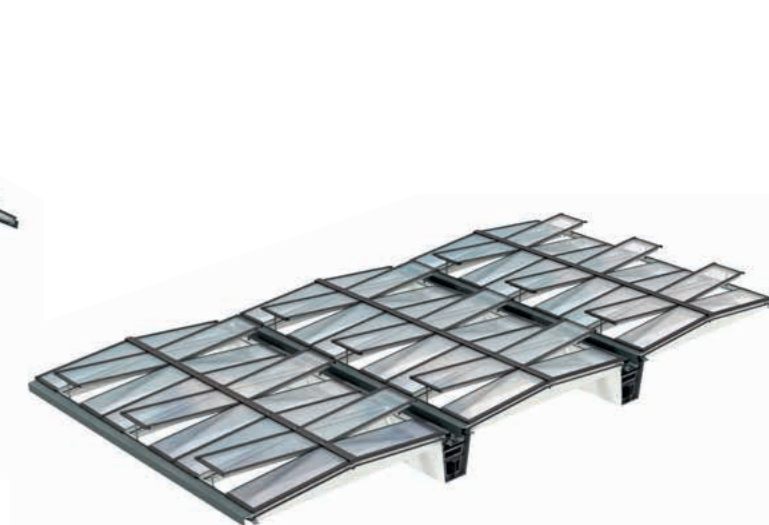

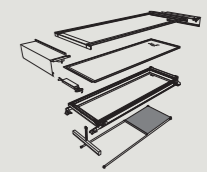



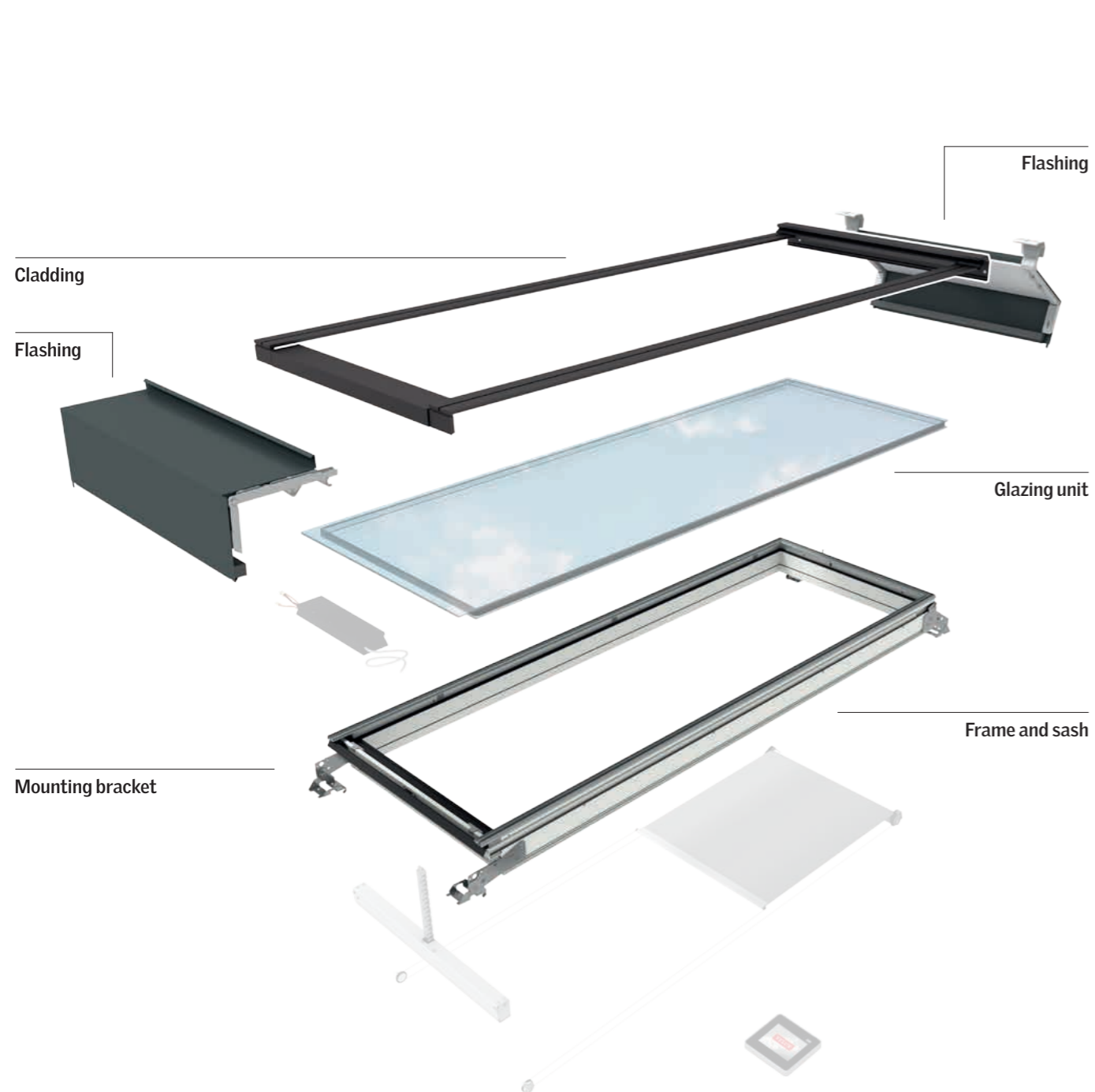

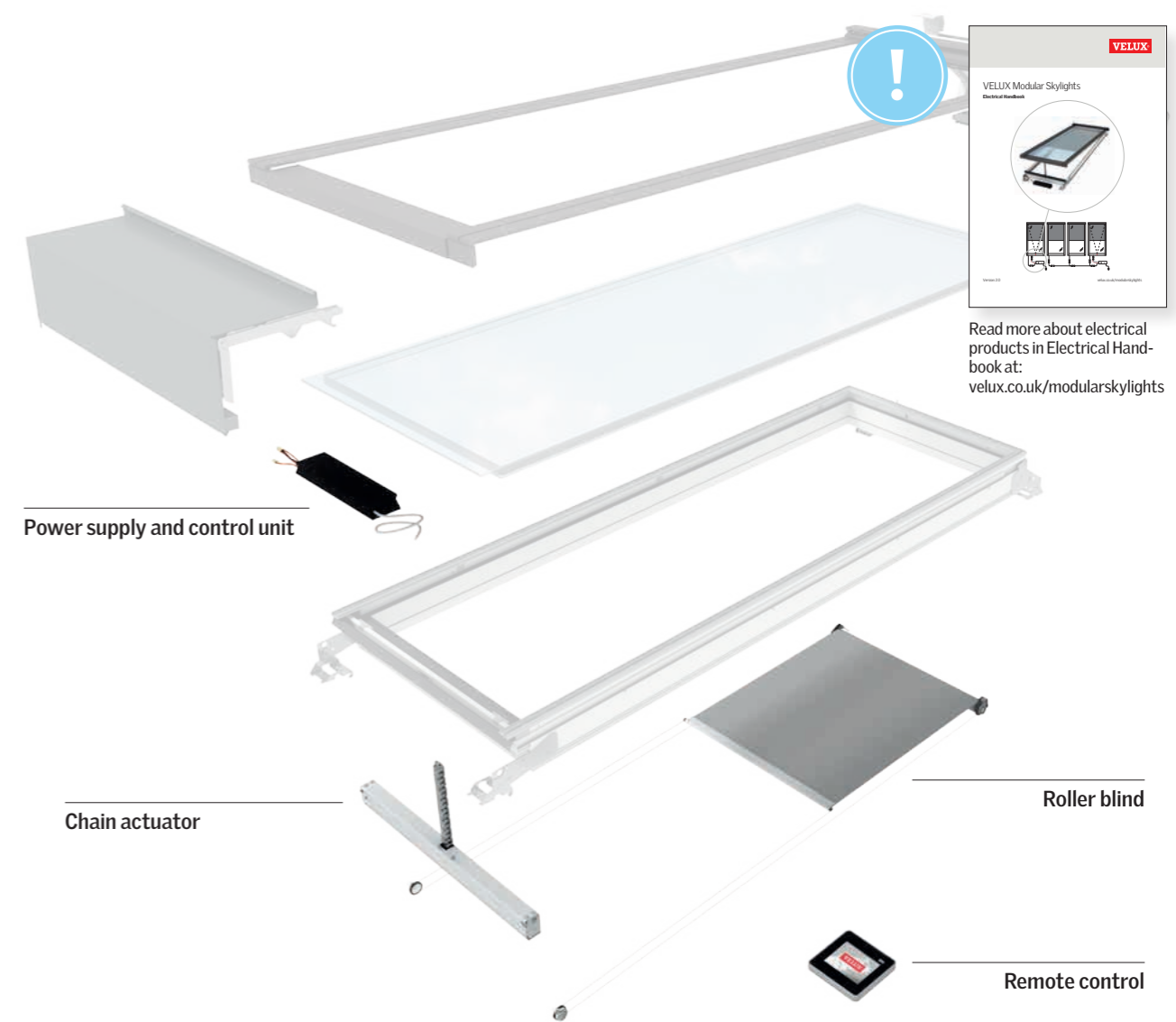

Module – Main Components



Module – Electrical Components



Remote control	Power supply and control unit	Rain and wind sensor unit	Wall switch	Interface for external wall switch	Interface for external control devices
					
KLR 200	KLC 400	KLA S105	KLI 110	KLF 050	KLF 200

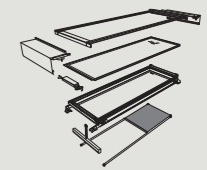

Frame & Sash

The main structural profiles of VELUX modular skylights consist of pultruded composite, containing approximately 80% continuous fibreglass threads and 20% two-component polyurethane resin.

The composite guarantees high heat insulating performance (graph 1) and thermal stability (graph 2) as well as excellent profile stiffness (graph 3) and strength (graph 4). In combination, the characteristics of the VELUX composite gives the slim profiles self-supporting strength and an ability to support installations of considerable size.

In addition the material is maintenance-free, non-corrosive and electrical non-conductive.

In combination with low-energy glazing units the VELUX modular skylights are able to achieve one of the lowest overall U-values for frame and glazing assembly within the skylight market. The inner surface is treated with white paint as standard. Other colours are available to special order.



Frame and sash assembled

Frame & Sash

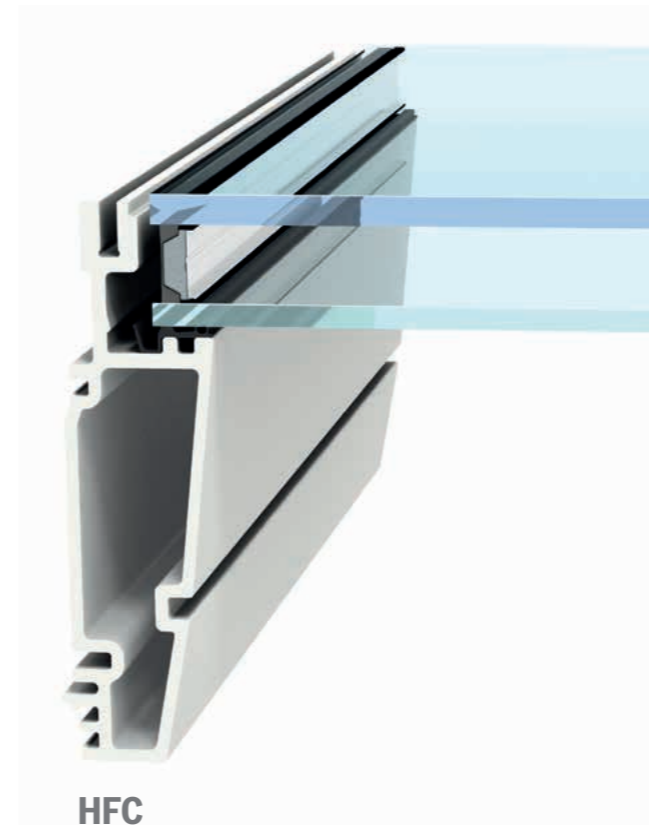

HFC

Frame for fixed skylight module

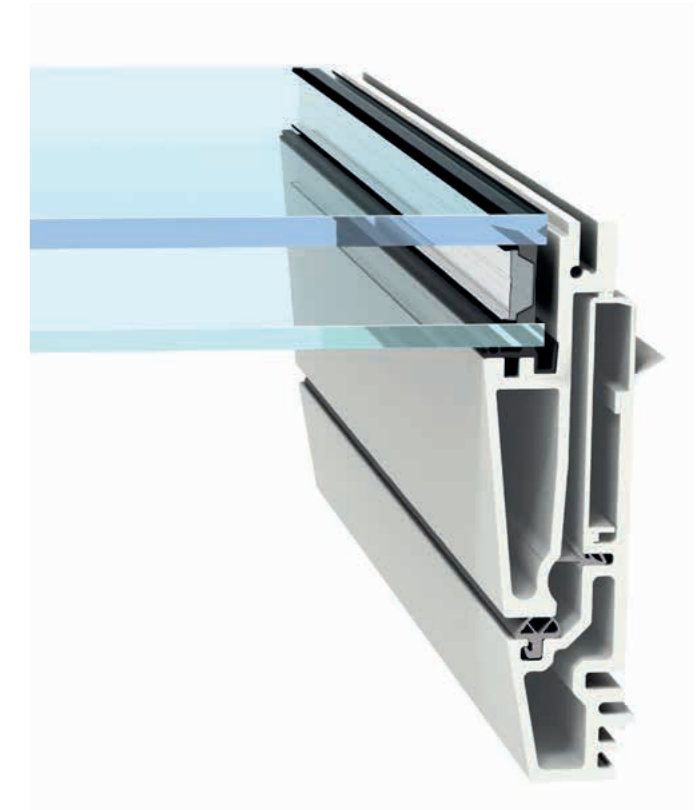

HVC

Frame and sash for venting skylight module

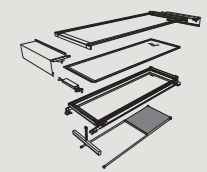

Frame & Sash

1 Thermal conductivity (W/mK)

- A low score means high insulation performance

Profiles used for VELUX modular skylights consist of pultruded fibreglass and polyurethane composite resulting in high insulation.

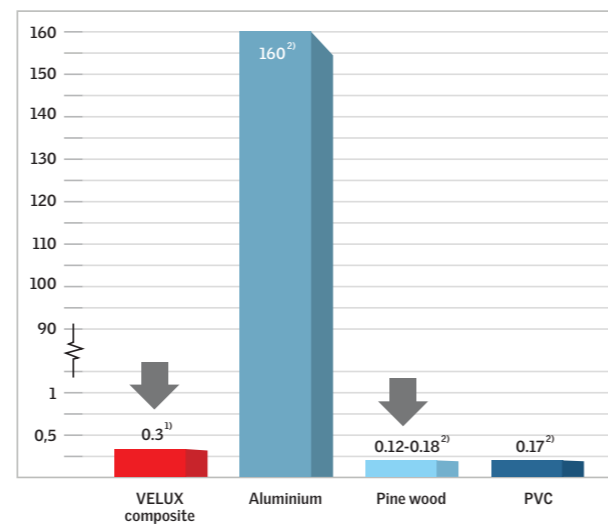

2 Linear expansion coefficient (10⁻⁶ m/mK)

- A low score means high thermal stability

Whereas traditional skylight materials are bound to fluctuations in form due to thermal changes, the composite of VELUX modular skylights will maintain its dimensional properties, ensuring tightness of joints and prolonging the expected lifetime of the application.

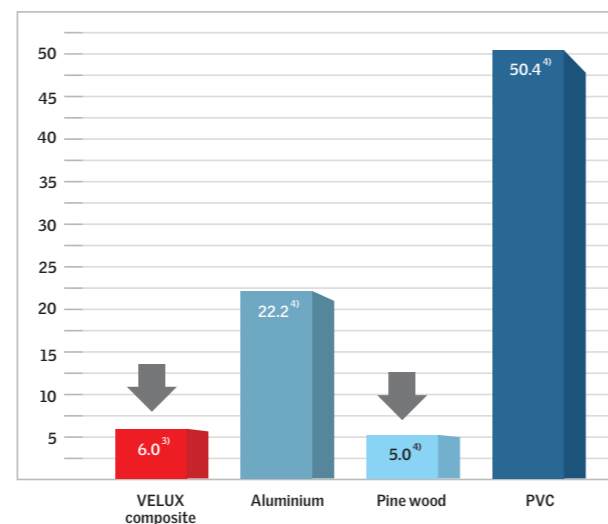

Source: ¹⁾ Accredited external tests ²⁾ According to EN ISO 10077-2 ³⁾ Value identical to fibreglass ⁴⁾ www.engineeringtoolbox.com ⁵⁾ Internal VELUX test

Frame & Sash

3 Flexural Modulus (E-Modulus) (GPa)

- A high score means low deflection

The high rigidity of the pultruded composite material results in very stiff frame and sash, ensuring reliable performance with very little deflection of the profiles and better aesthetics of the skylight.

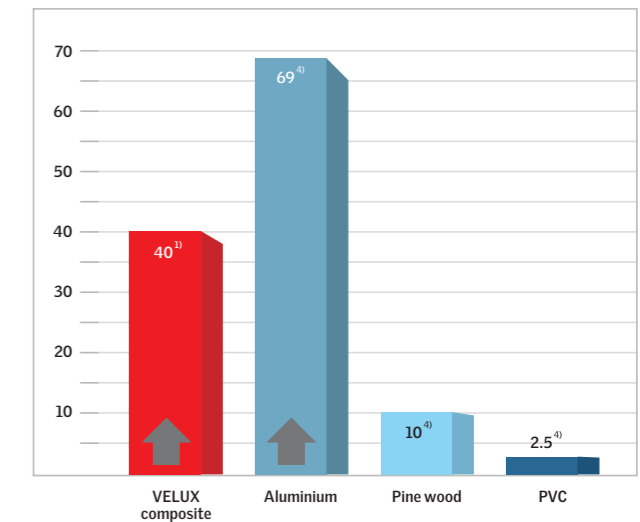

4 Flexural Strength (N/mm²)

- A high score means high strength

The very high strength of the pultruded composite material allows for design and production of longer and slimmer frame and sash profiles than traditional skylight materials. This enables design of large skylights with slim profiles resulting in better aesthetic performance.

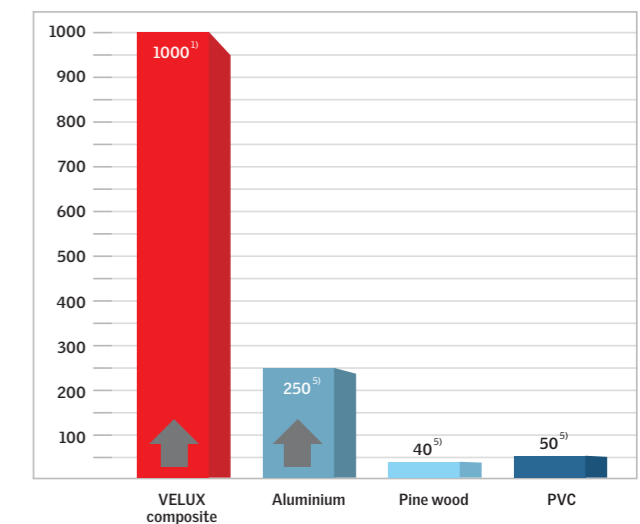

Source: ¹⁾ Accredited external tests ²⁾ According to EN ISO 10077-2 ³⁾ Value identical to fibreglass ⁴⁾ www.engineeringtoolbox.com ⁵⁾ Internal VELUX test

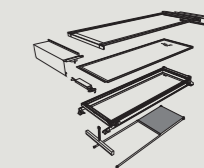

Cladding

Cladding

Each single module has an assigned set of claddings. Cladding components are attached on four sides of the skylight, ensuring a water-tight connection. The cladding is made of extruded aluminium,

which is covered with a scratch resistant, granite grey, powder coating for added weather protection and aesthetics. Other colours are available at premium price.



Flashing

Flashing

VELUX modular skylights come with factory-finished flashings. The pre-fabrication of flashings ensures a high quality solution and safe and fast installation process. The flashing has a top, side and

bottom section made from aluminium with a grey paint finish. Other colours are available at premium price.



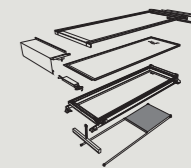

Glazing Unit

VELUX modular skylights come with a low-energy doubleglazing unit. Alternatively the skylight modules can be supplied with improved solar protection or a krypton filled triple-glazing unit for extra-low U-value. All glazing units include a toughened outer glass layer and a 3+3 or 5+5 mm safety inner glass layer with 2 x 0.38 mm interlayer PVB foil. For technical values on glazing units, please refer to the chapter about Product Data.

The triple-glazing units have a heat-strengthened middle glass layer. Heat strengthened glass is also utilised for the inner pane of triple-glazed units with a 5+5mm inner pane.

The cavity between the panes of the glazing units is filled with argon gas or krypton as a default.

All glazing units consist of a warm edge spacer and they are produced with warm edge technology to minimise the risk of condensation at the pane edges to provide the glazing units with the most durable insulation capabilities.



Example of double-glazing unit (LowE)

Variant 10

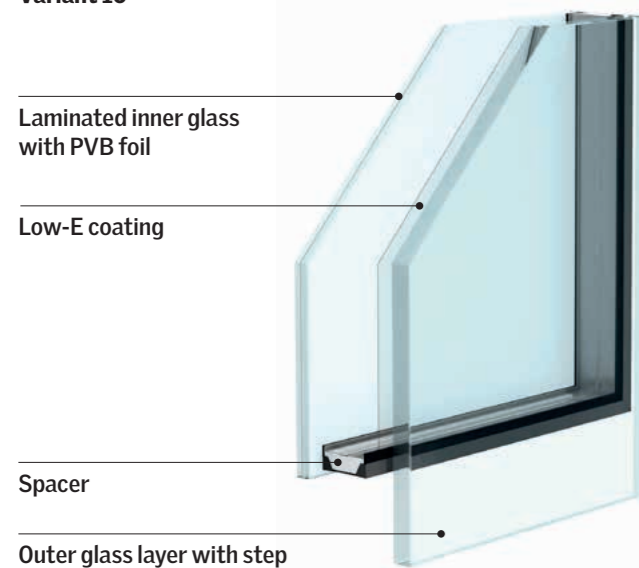

Example of triple-glazing unit (LowE)

Variant 16

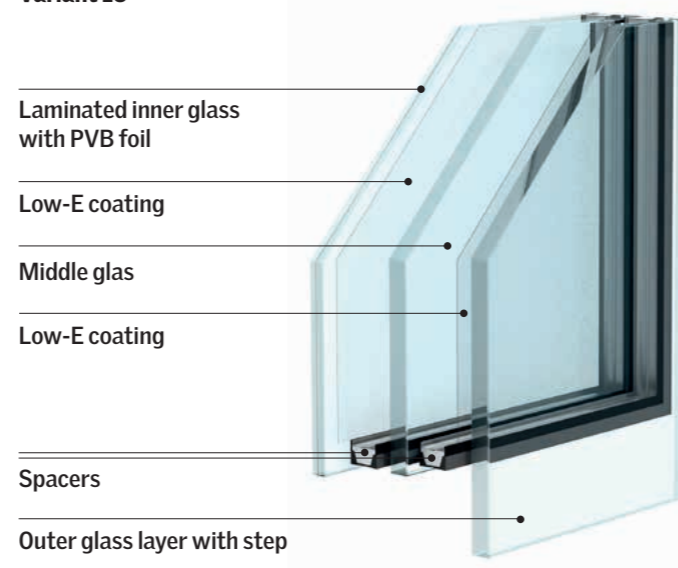

Note: Visual quality of glazing units. Interference effects and/or effects specific to multiple glazing and/or anisotropy may occur in the visible glass surface due to the physics of the material and its production technologies.

Glazing Unit

Colour renderings of double-glazing units

Additional glazing characteristic's and glazing variants are shown on page 66/67.



Glazing with low emissivity coating (LowE)

Variant 10

T-value = 79%
g-value = 59%
R_a = 96.4

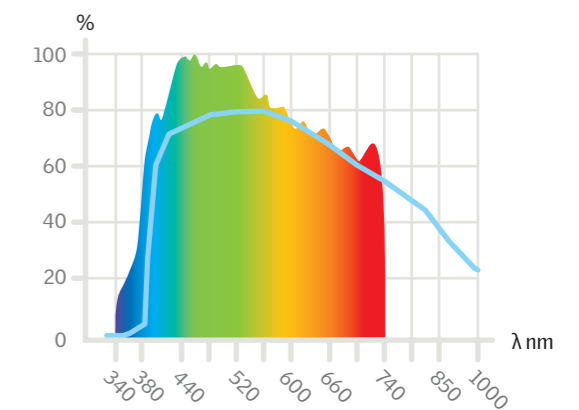

Glazing with light added sun protection coating (Sun1)

Variant 11

T-value = 49%
g-value = 27%
R_a = 91.2

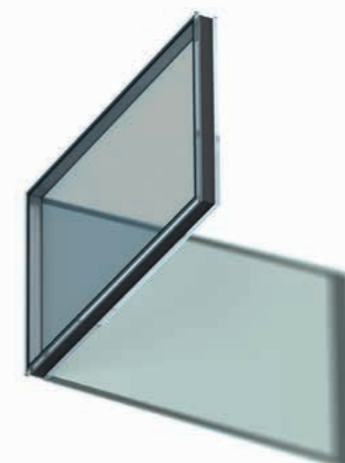
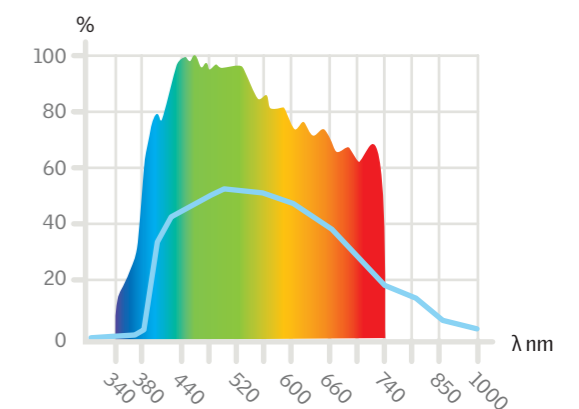

Glazing with high sun protection coating (Sun2)

Variant 12

T-value = 18%
g-value = 16%
R_a = 90.7

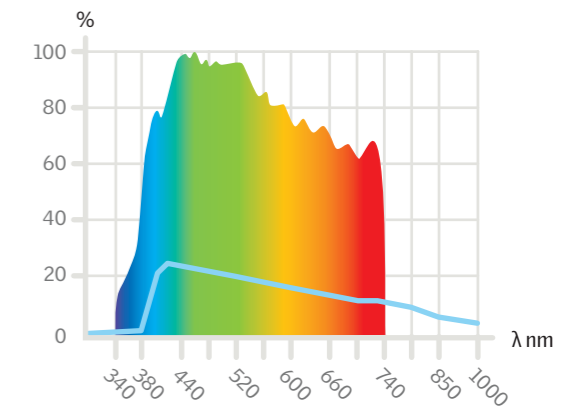

Spectral values (wave length in nm)
Visible daylight tau

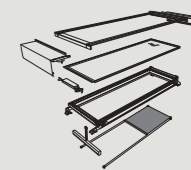

Brackets & Hinges

Material and surface treatment

Metal components in VELUX modular skylights are made of galvanized steel.

The majority of the steel components are electroplated according to European norm EN ISO 2081 table A1 - C: iridescent. Components fulfill corrosion resistance grade 4 in accordance with EN ISO 1670.

Based on these properties, VELUX modular skylights can be used where external weather conditions and indoor climate conditions remain within the normal spectre of corrosiveness.

Note: VELUX modular skylights must NOT be used in indoor environments, where the risk of condensation on metal components can lead to extreme corrosive attack. Environments include buildings with swimming pools and other similar facilities that use highly corrosive substances, e.g. salt and/or chloride. Evaporation can lead to corrosive attack on components, weaken the functionality and in the end compromise the structural integrity of the installation.

Brackets

VELUX modular skylights are supplied with mounting brackets and clamps and are ready to be installed on any preferred sub-construction made of steel, concrete or wood finished with a steel profile at the top. Mounting brackets are fixed during installation with a clamping system holding the skylight in place.

Using a steel profile on top of the sub-construction provides benefits, since the clamps at any time during installation can be released to allow minor positional adjustment of the modules.

If the skylight modules are mounted on the batten using screws through the top- and bottom brackets. These screws are not included in the VELUX delivery, and the correct dimensions must be ensured by the customer.

Hinges

The pre-fitted hinges of the venting modules are tested under the most severe conditions, using the largest and heaviest modules to open and close continuously.



Examples of Brackets & Hinges



Clamp for fixing mounting bracket on steel profile

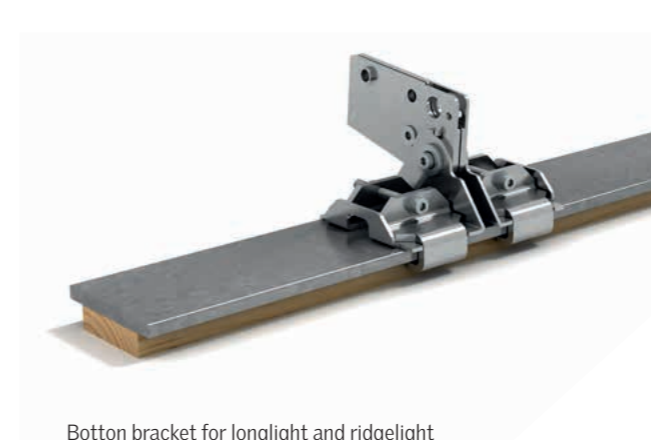

Bottom bracket for longlight and ridgetlight

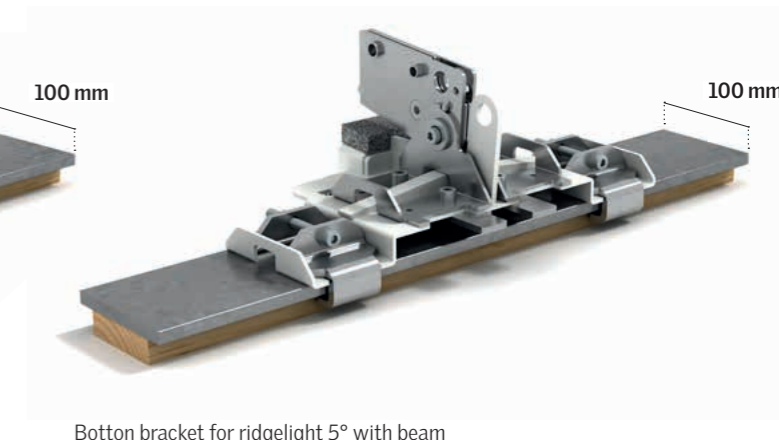

Bottom bracket for ridgetlight 5° with beam



Top bracket for northlight

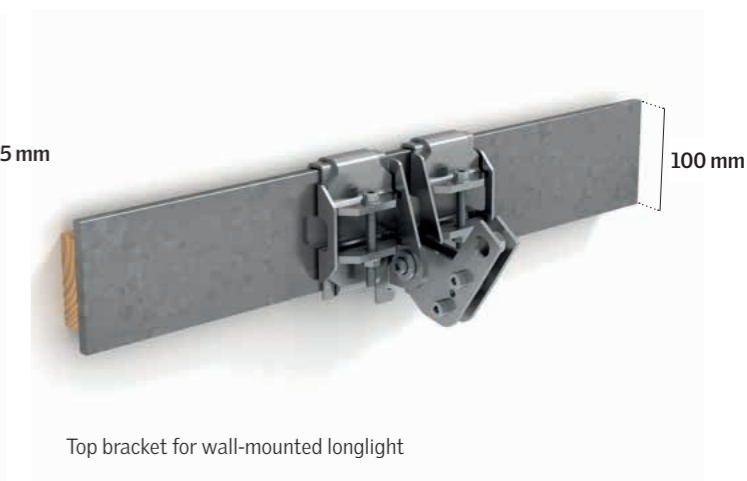

Top bracket for wall-mounted longlight



Top bracket for ridgetlight 5° with beam



Top bracket for ridgetlight 25 - 40°

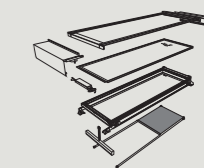

Module - Assembled



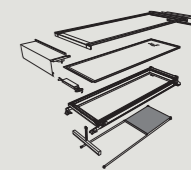

Vapour Barrier Connection Strip

To ensure a high quality installation of VELUX modular skylights and to prevent condensation occurring within the kerb construction, it is highly recommended to install the BCX vapour barrier connection strip.

The factory-finished BCX creates the perfect connection between the VELUX modular skylights and the vapour barrier of the building.

The vapour barrier connection strip BCX is made of a diffusion-tight polyethylene membrane completed with a pre-fitted rubber gasket along one edge. With a perfect fit into the skylight frame rebate, installation is an easy job that guarantees a vapour-tight solution.



The factory-finished BCX

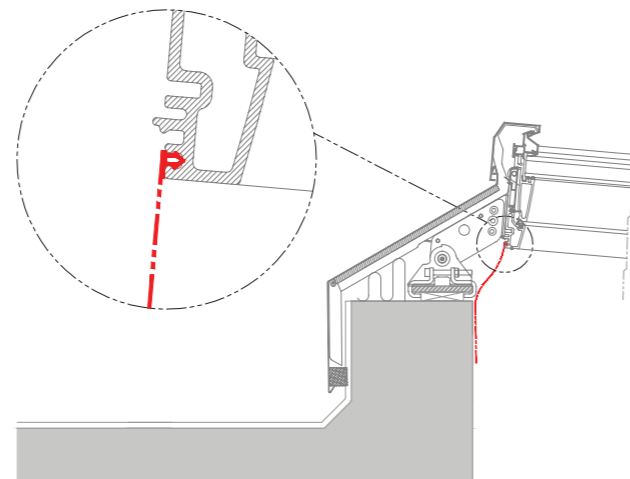

Position of BCX



Chain Actuator

Venting VELUX modular skylights are top-hung and use a hidden chain actuator integrated at the bottom profile. There are two variants of the chain actuator. You can either choose the VELUX INTEGRA® system based on the io-homecontrol® technology and use the VELUX INTEGRA® control pad, KLR 200, for user-friendly control.

Alternatively you can choose the open system variant and connect the installation to your preferred building management system. The open system chain actuator can be programmed even after installation to suit specific needs, e.g. speed, tensile, compressive force, noise level and power consumption.

These parameters and functions can be changed via the green communication wire if connecting to WindowMaster MotorLink™ control.

The chain actuator for VELUX modular skylights has a built-in reversing function that prolongs the lifetime of the gaskets.

The chain actuator is accessible from the roof. Therefore maintenance requires no access from the inside of the building.

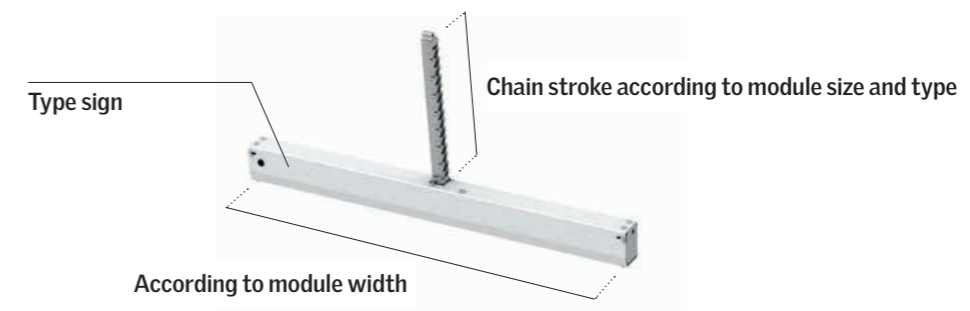

VELUX modular skylights have a recommended minimum installation height of 2.5 m above floor level (inside) and ground level (outside). In case of installation below that level, safety measures must be applied by the installer/user to prevent serious injury. No instruction or measure can eliminate the inherent hazards resulting from installation height below 2.5 m.

VELUX will not accept responsibility for damages, injury or death resulting from such installation. The installer/user is ultimately responsible for own omissions and actions. Measures could be for instance a motion sensor able to disconnect power from the control unit in case of any movement in the immediate vicinity of the VELUX modular skylights.

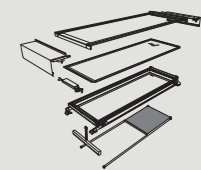

Control System

VELUX INTEGRA®

Venting modular skylights and blinds controlled with the VELUX INTEGRA® system will be powered and controlled from the control unit KLC 400. Each KLC 400 can operate one venting skylight module and up to four roller blinds individually, in groups or simultaneously.

Skylight systems installed with the VELUX INTEGRA® system are controlled with the VELUX INTEGRA® control pad, KLR 200, which allows the skylight modules and blinds to be set in any position and offers a range of programming features.

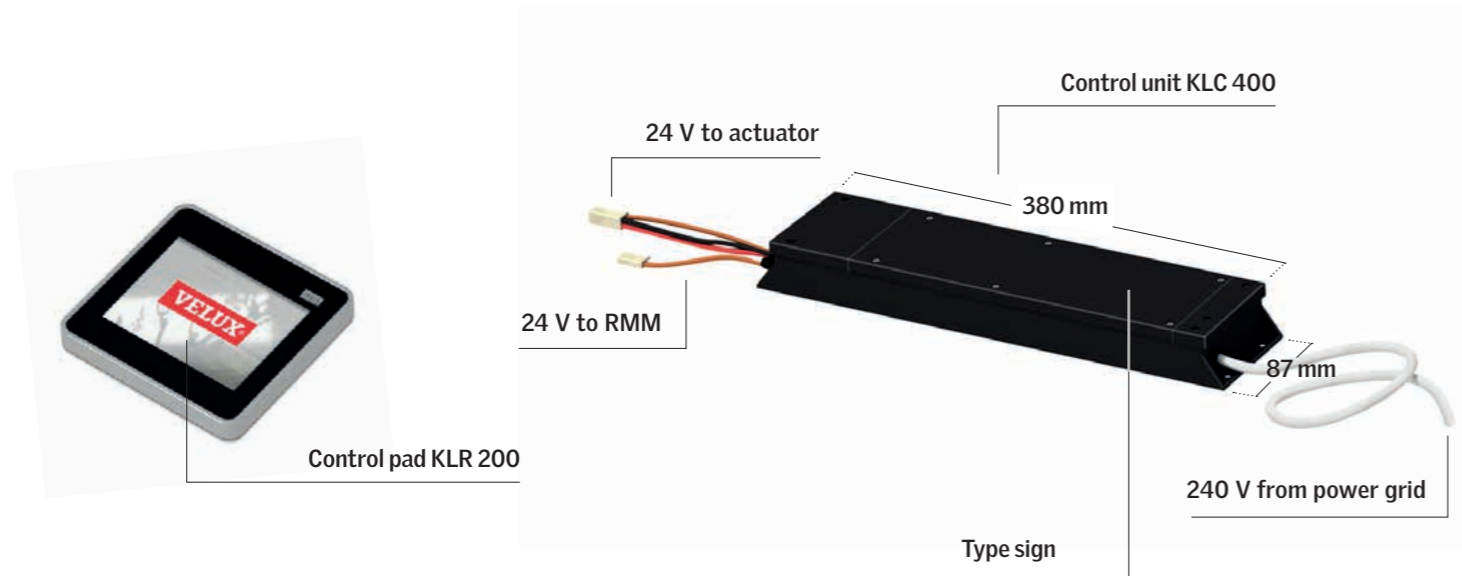

Open system

Venting modular skylights and blinds controlled with the open system solution are connected to ± 24 V DC. In addition to ± 24 V DC the open system skylights and blinds can be connected to, and integrated in, common building automation fieldbus systems, i.e. KNX,

BACnet, LON and Modbus. The connection is made through the integrated WindowMaster MotorLink™ technology that among other things enables exact position control, feedback and speed control.

Wind deflector for smoke ventilation modules

The wind deflector KCD W00H00 0040 is intended to be used with smoke ventilation modular skylights. The wind deflector is designed to change the wind profile over the skylights in open position, in order to minimize the risk of air intake and allow outtake of smoke even in unfavorable wind conditions, same time causing the possible less visual effect on the exterior of the skylight. The wind deflector KCD exists in one variant, fitting all skylight module sizes.

The deflector can be purchased and installed at the same time as the smoke ventilator, or can be installed subsequently. In any case the aerodynamic free area of the smoke ventilators is declared both with and without deflector, from which the applicable performance and influence of the deflector on the performance must be respected.

The deflector is tested together with VELUX modular Skylights in accordance with EN 12101-2. For more explanation on the performance of smoke ventilation modular skylights and the influence of the deflector on the aerodynamic free area see page 59-63.



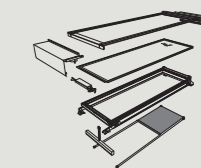

Roller Blind





The internal roller blind, RMM, is designed for installation with VELUX modular skylights, and is available in all standard module sizes. The blind protects against heat and glare and helps to control the amount of light in the room.

The blind consists of four wheels located in each corner of the skylight module and two steel wires, running along the module side frame. The two wires pull a lightweight polyester fabric available in three commonly used colours.

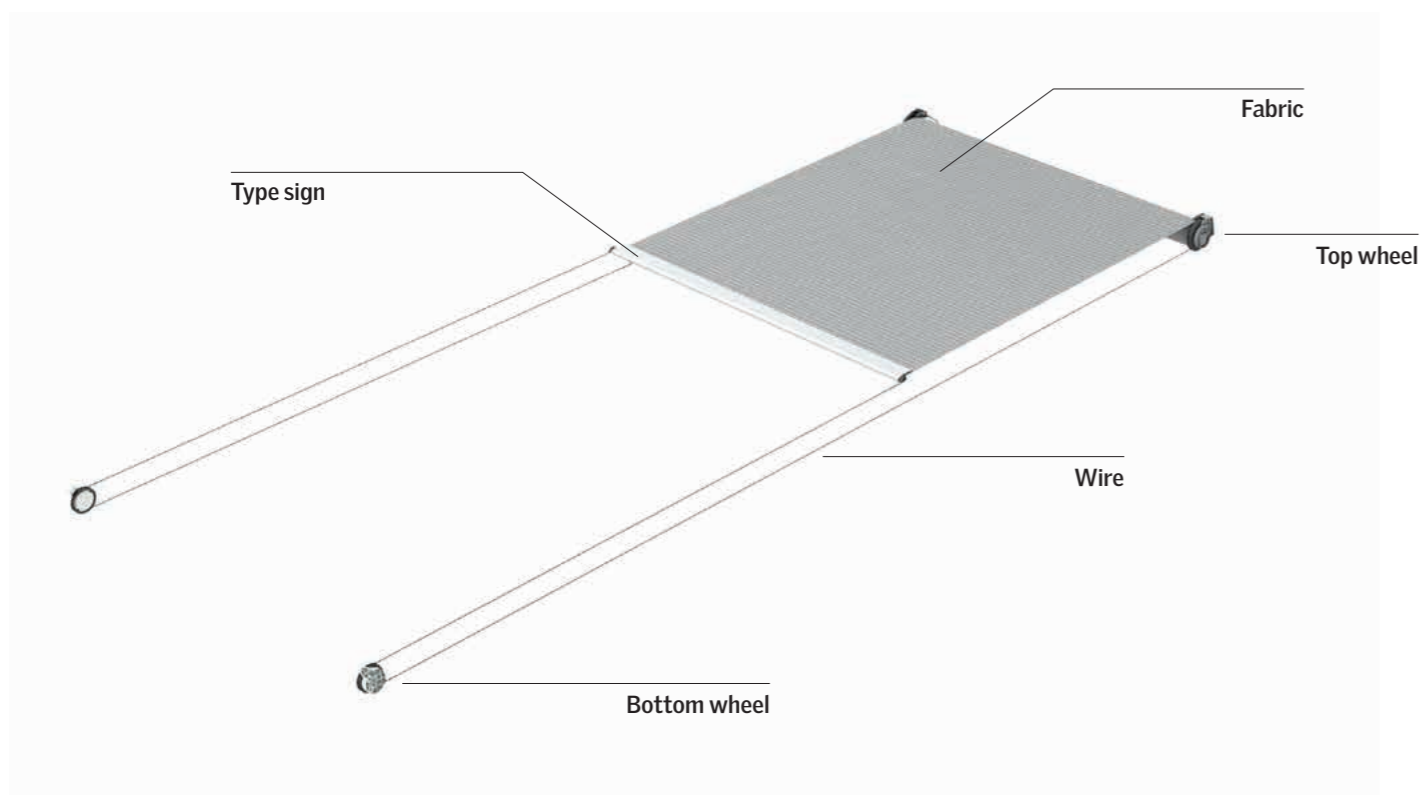
Since all standard sized VELUX modular skylights have cables for internal blinds pre-installed, securely connecting the blinds to the terminal block at the top of the module and to the power supply is quick and easy.

To support fast and safe installation of VELUX modular skylights it is possible to order roller blinds pre-mounted from the factory.

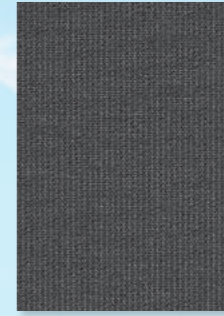

	Sunscreening			Fire resistant
				
Colour	Grey	White	Black	White
Variant code	RMM 4083	RMM 4084	RMM 4085	RMM 4094

Order the right size

To order the right sizes see the type sign on the VELUX modular skylight.
How to read the type sign see page 35.





Beam for Ridgelight at 5°

When installing VELUX modular skylights in a 5° ridgelight solution, the modules are supported by a steel beam. The beam is included in the VELUX delivery and is ready for fast and easy installation with no further preparation.

VELUX Beams are treated with a white primer as standard and available for modules from 1200 to 3000 mm in height.

VELUX beams do not come with a fire rating as a standard. If such a demand occurs, please be advised: For up to 30 minutes of fire resistance, clients will need to purchase a) modules with fire resistant glazing units and intumescent strip (HVS/HFS) and b) ask the local fire authorities to assess the fire properties of the beam.

If the beam is required to meet these increased demands for fire resistance, it must be treated with fire paint. Clients are advised to inform the local VELUX sales company of such demands prior to order, as standard beams have not been primed for fire paint. Please note that fire paint will change the visual appearance of the beams slightly.

If there are no specific fire rating demands for the modules, but specific demands for the beams, only point b) is relevant.

Always take into consideration that it is only possible to make beams fire rated for up to 30 minutes. If fire rating demands exceed 30 minutes, 5° ridgelight configurations are not suited for this installation.

Beam for Ridgelight at 5°

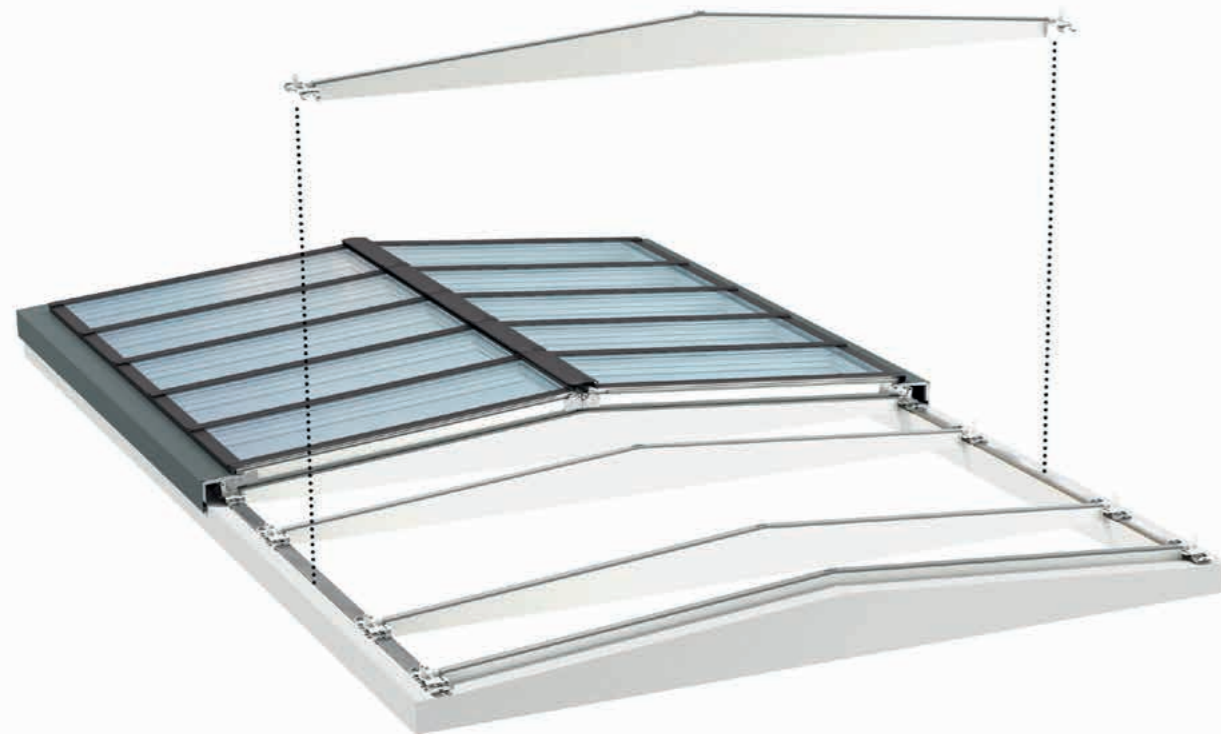

Type Sign

All VELUX modular skylights, electrical components and accessory products have a type sign sticker. The type sign helps to identify the product and must NOT be removed.

If a product is damaged or malfunctioning, the VELUX sales company must be informed about information given within the type sign.

Example of type sign and position

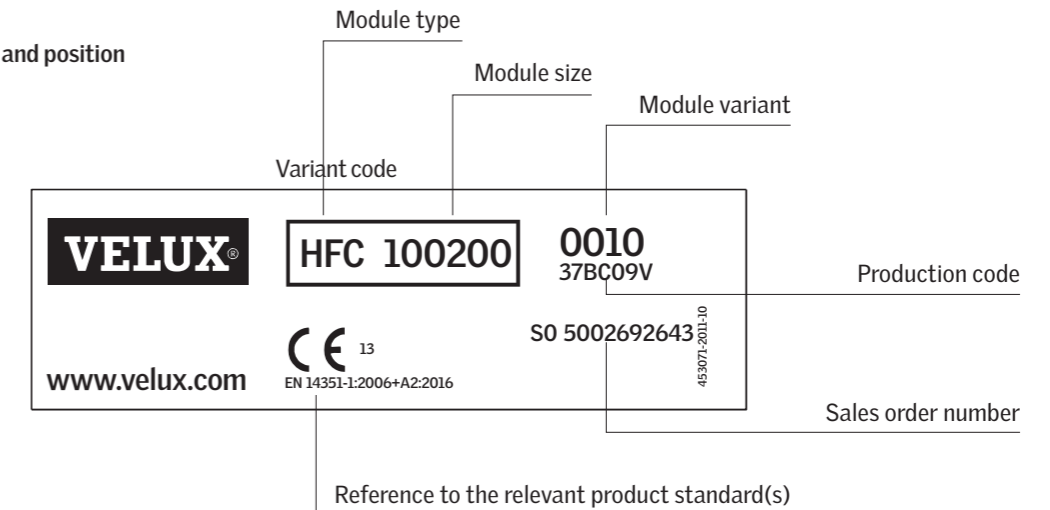

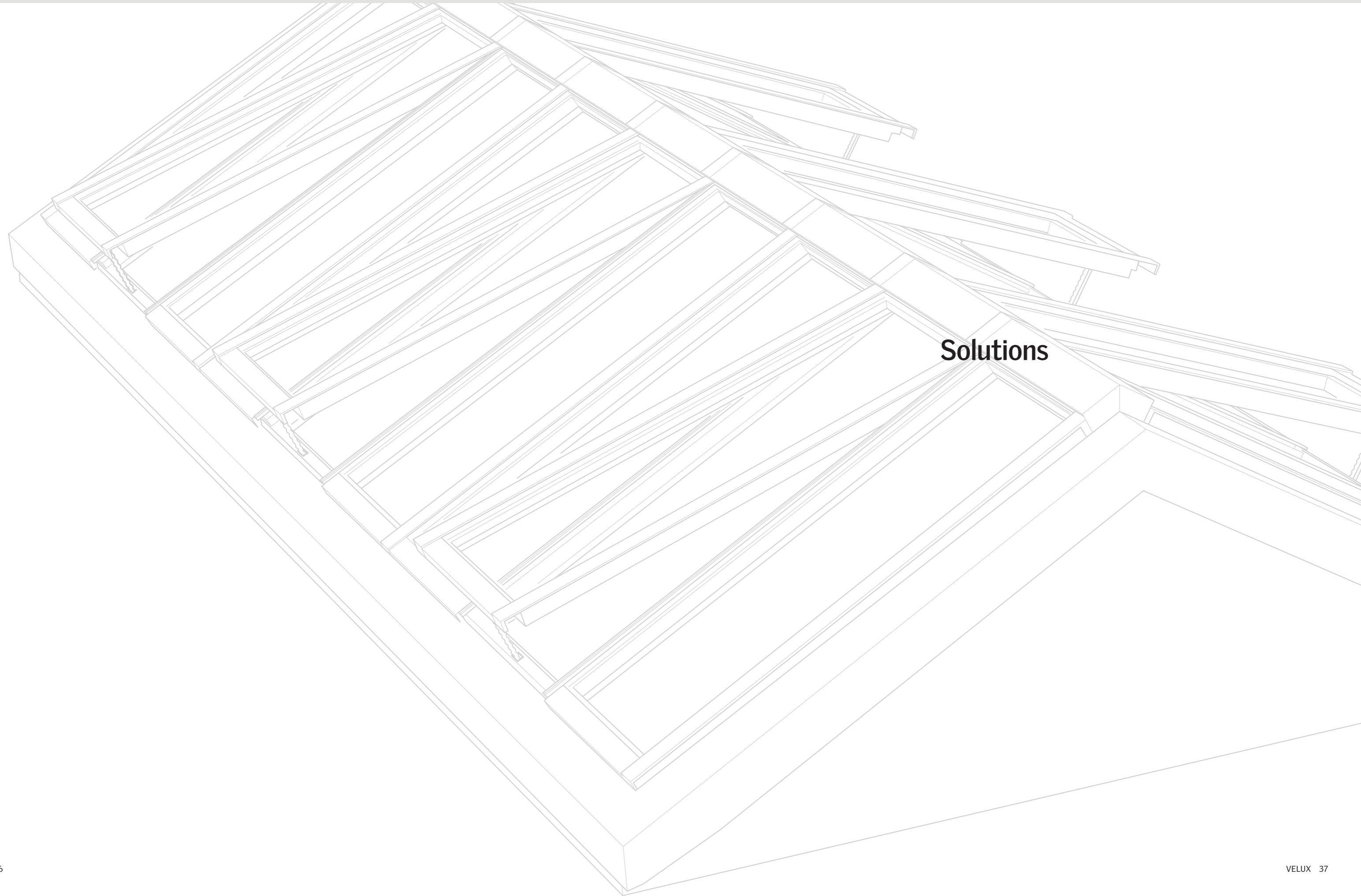



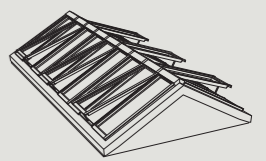



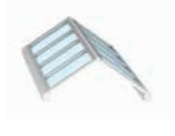
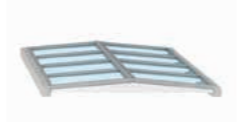

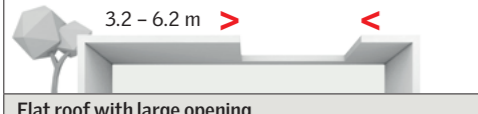
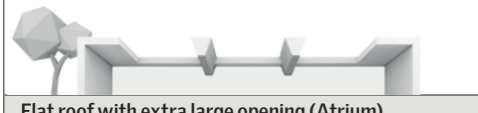

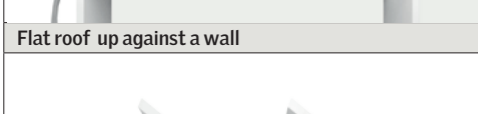
Solutions

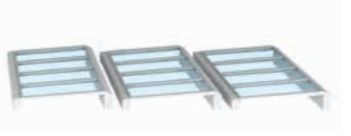

Quick Overview of Skylight Solutions vs. Roof Constructions

			
Solution*	Longlight	Ridgelight	Ridgelight with 5° Beam
Installation pitch	5-25°		5°
HFC = fixed modules, HVC = venting modules	HFC	HVC	HFC
Opening width (Length = ∞) **	1.2 - 3.1 m	1.2 - 2.5 m	2.0 - 4.5 m
 1.2 - 2.5 m > <	✓	✓	
Flat roof with small opening			
 2.0 - 4.5 m > <	✓	✓	✓
Flat roof with medium opening			
 3.2 - 6.2 m > <		✓	✓
Flat roof with large opening			
			
Flat roof with extra large opening (Atrium)			
			
Flat roof up against a wall			
			
Northlight			
	✓		
Sloping roof with opening in the side			
		✓	
Sloping roof with opening as ridge			

			
Northlight	Wall-mountet Longlight	Atrium Longlight	Atrium Ridgelight / Atrium Ridgelight with 5° Beam
25-90°	5-40°	5-25°	25-40° / 5°
HFC	HVC	HFC	HVC
1.3 - 3.1 m	1.3 - 2.5 m	1.1 - 3.2 m	1.1 - 2.6 m
		✓	✓
	✓		
✓			
✓			

* Please note that all solutions, independently of roof construction, require installation on a sub-construction designed according to instructions given by VELUX.
 ** Measurements are guidelines only. Exact numbers will be supplied by your VELUX Sales company.

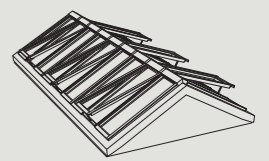

Longlight 5 - 25°

Longlights are bands of VELUX modular skylights, supplied with installation brackets and clamps that guarantee a fast and secure installation. The pre-fabricated flashing allows for configurations with a pitch of 5 to 25°.

Longlights are mounted on a standard steel profile of 100 mm width (not a VELUX component). The brackets are fixed with a clamping system holding the skylights in place. It is also possible to install the mounting brackets of a longlight directly onto a wooden batten without using the clamps.



Sub-construction for Longlight at velux.co.uk/modularskylights

Use the table to define module height (H) and/or installation pitch (α).

Example:
A = 2500 mm

Result:
 α_1 : H = 2400 mm at installation pitch of 5°
or
 α_2 : H = 2600 mm at installation pitch of 23,5°

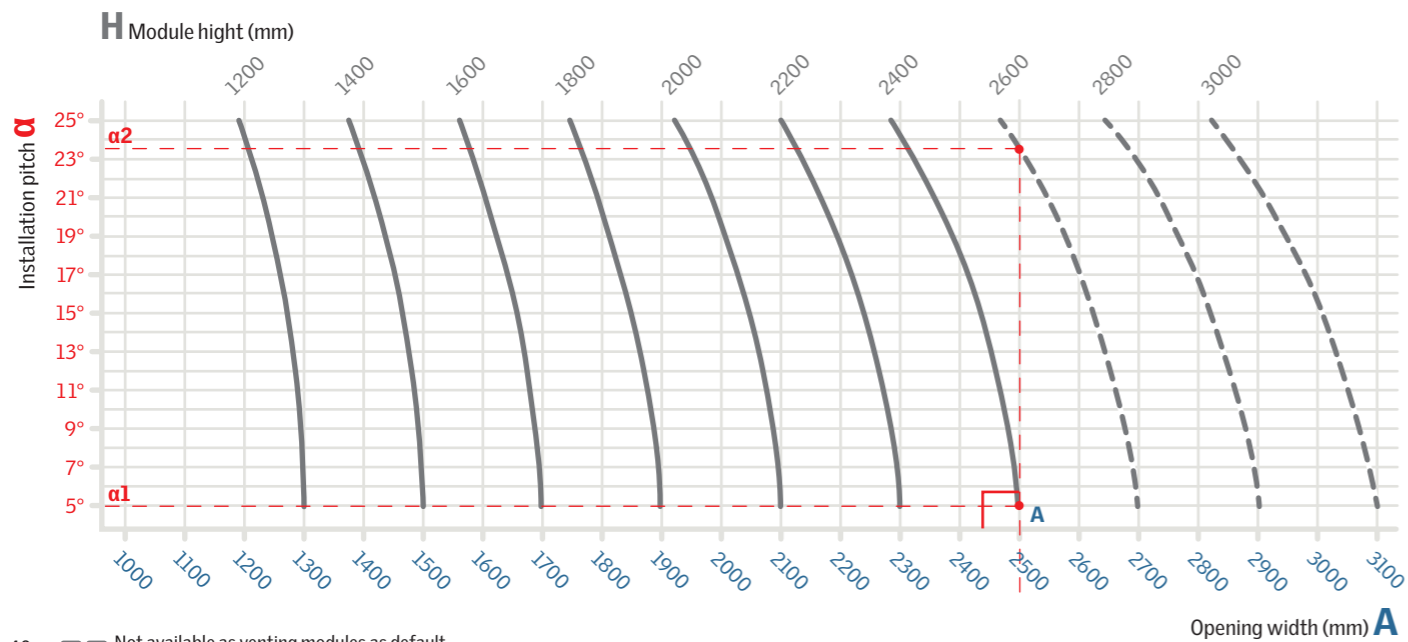
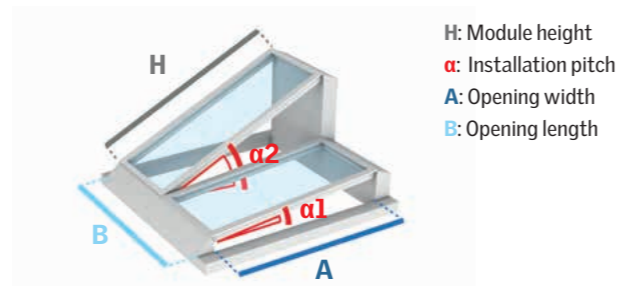

40 — Not available as venting modules as default. Measurements in the above example are guidelines only. Exact numbers will be supplied by your VELUX sales company.

Sectional Drawings

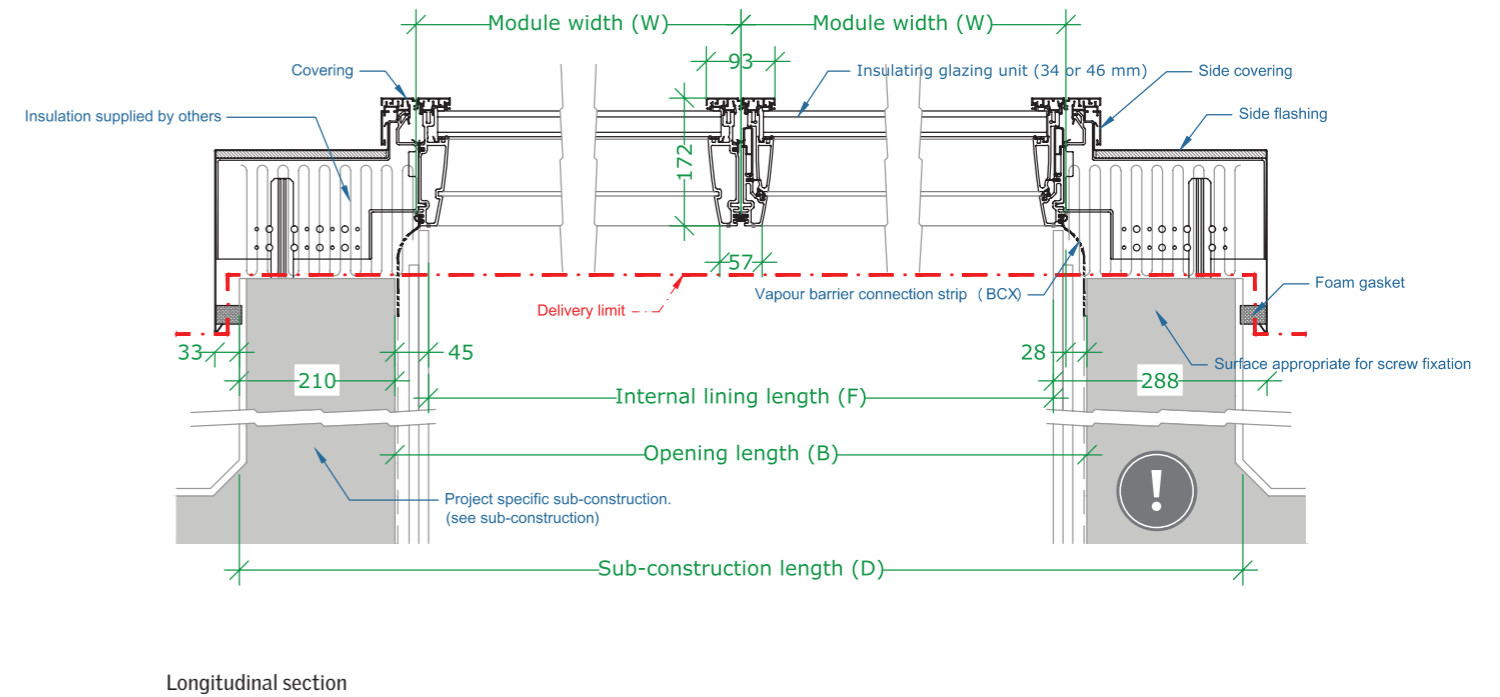
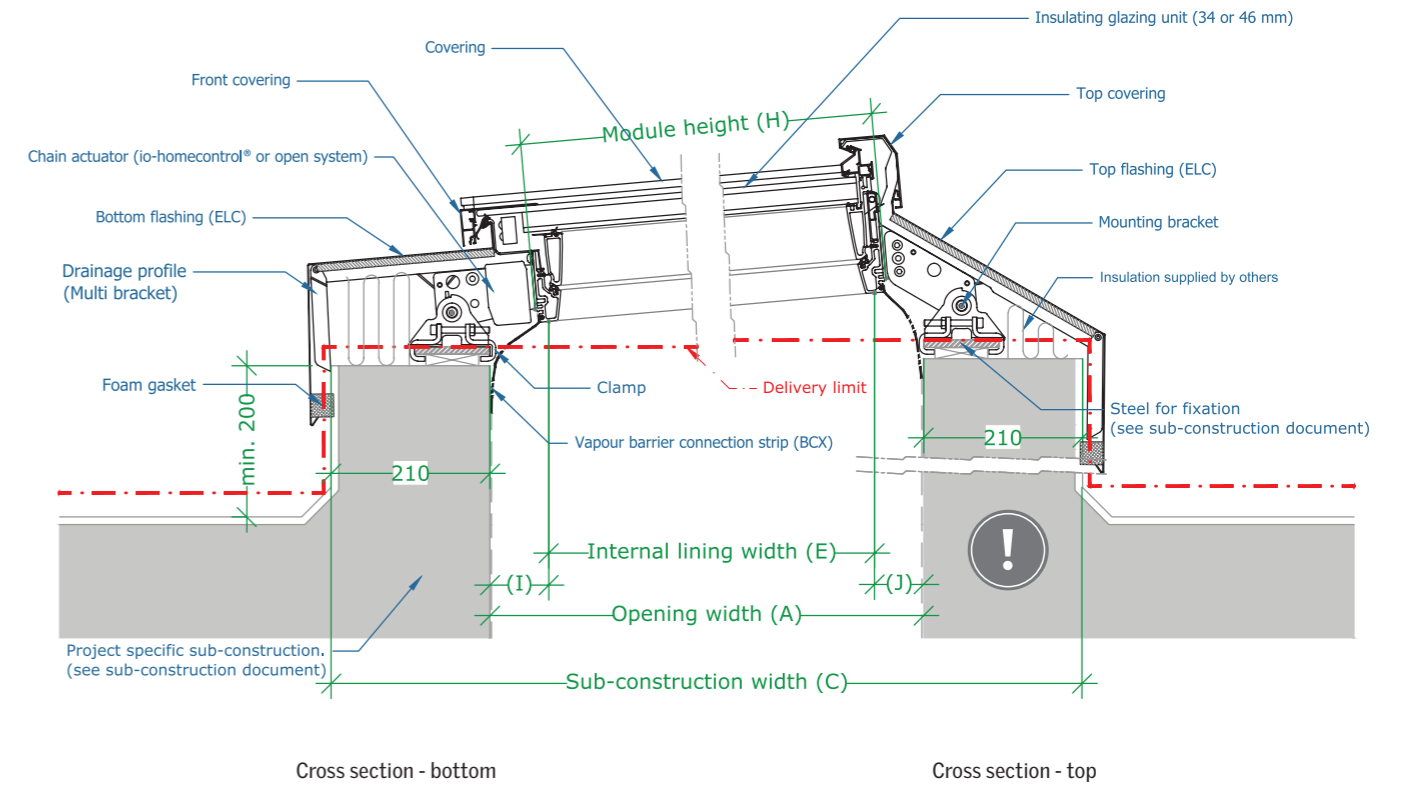

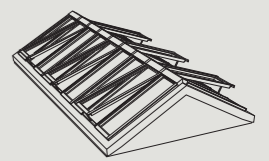

Wall-mounted Longlight 5 - 40°

Wall-mounted longlights are bands of VELUX modular skylights mounted against a vertical wall. As the skylight modules are supplied with installation brackets and clamps a fast and secure installation is guaranteed. The flashing allows for configurations with a pitch of 5° to 40°.

Wall-mounted longlights are mounted on a standard steel profile of 100 mm width at the wall. At the bottom you can choose to mount the skylights on either a steel profile using the clamping system or directly onto a wooden batten without using the clamps. The steel profiles and wooden battens are not VELUX components.

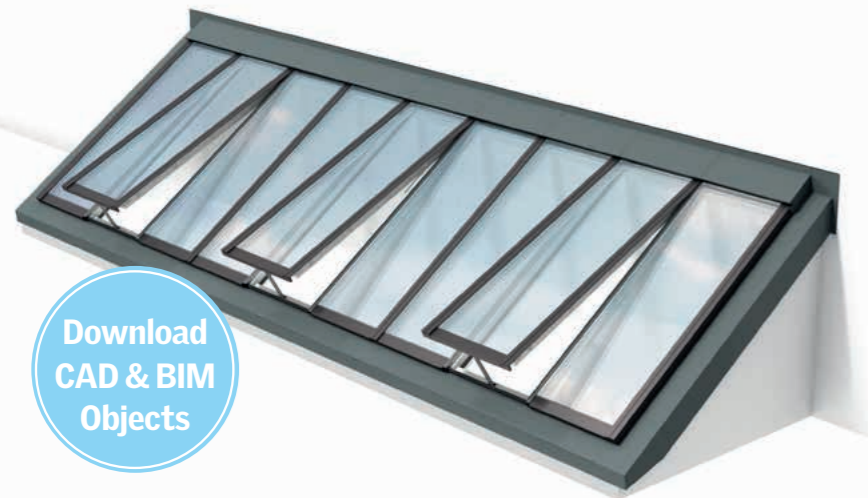

Download
CAD & BIM
Objects



Sub-construction for wall-mounted longlight at velux.co.uk/modularskylights

Use the table to define module height (H) and/or installation pitch (α).

Example:
A = 1800 mm

Result:
α1: H = 1800 mm at installation pitch of 24°
or
α2: H = 2000 mm at installation pitch of 34°

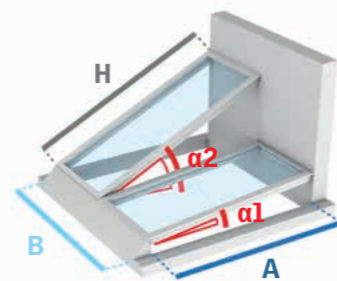

H: Module height
α: Installation pitch
A: Opening width
B: Opening length

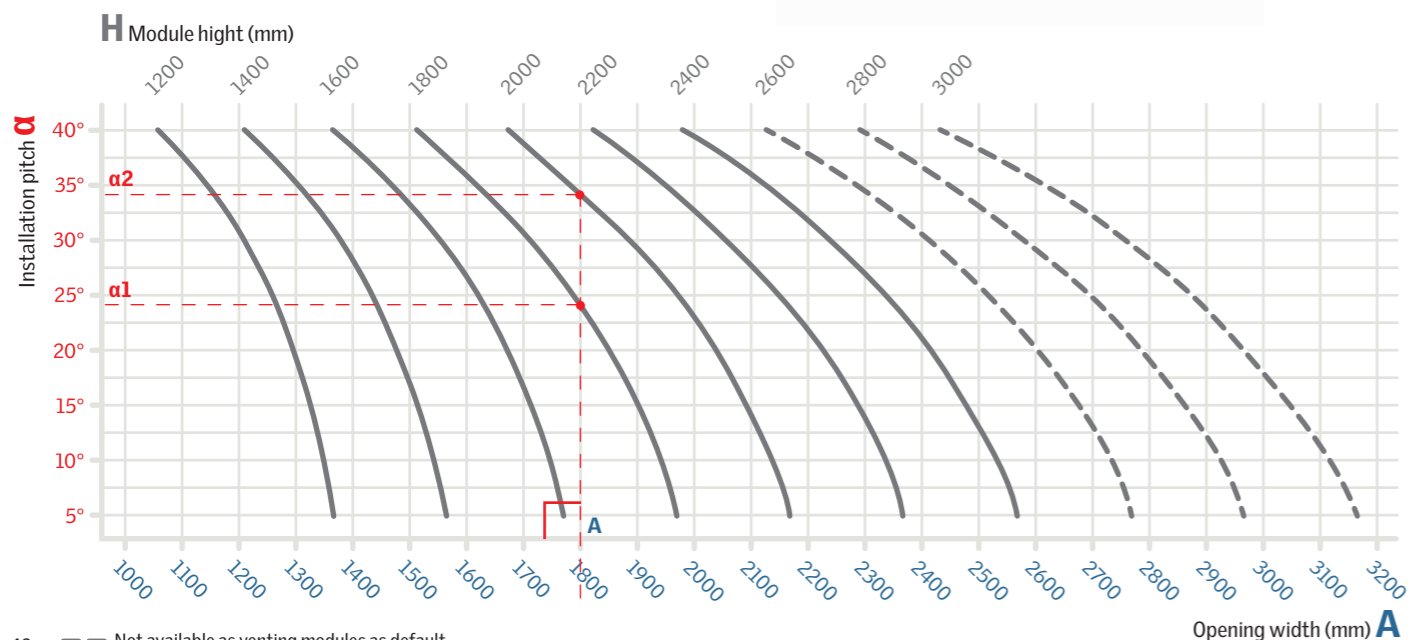

42 — Not available as venting modules as default. Measurements in the above example are guidelines only. Exact numbers will be supplied by your VELUX sales company.

Sectional Drawings

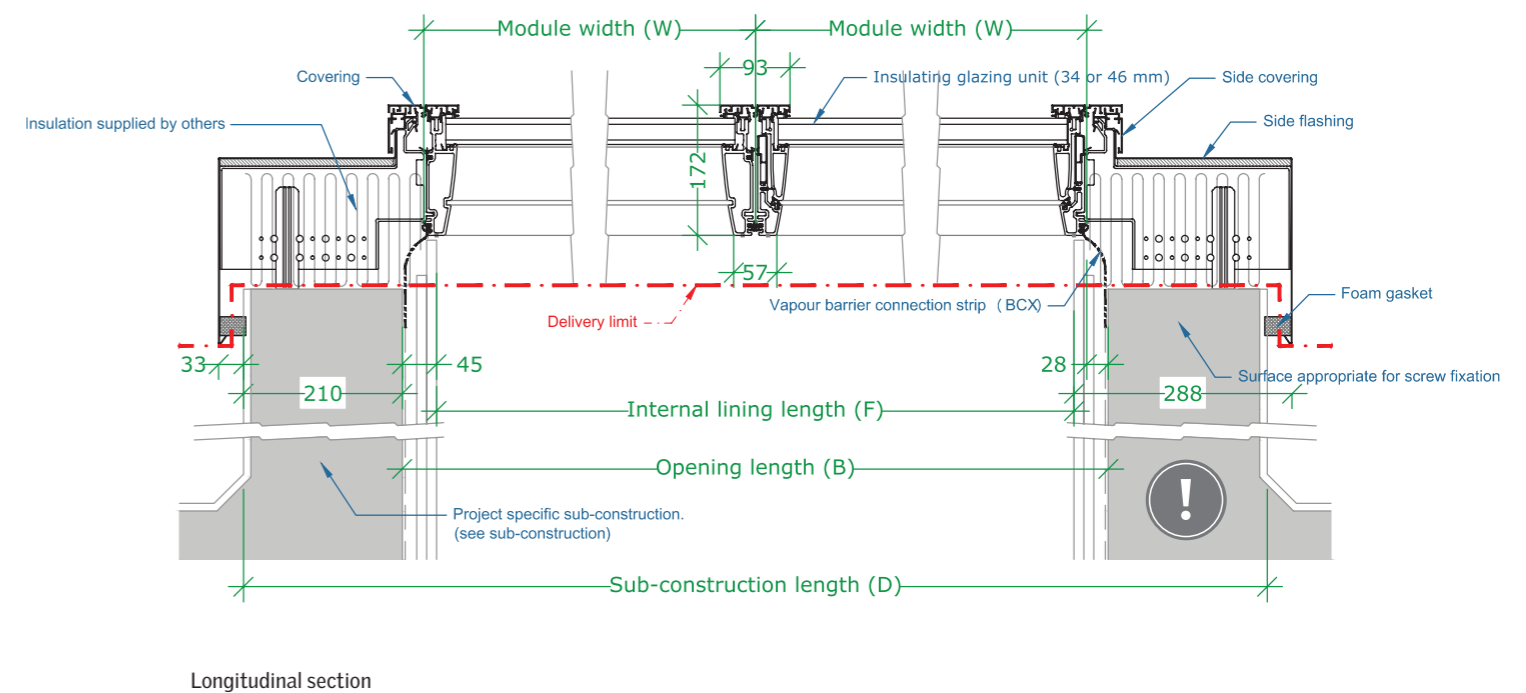
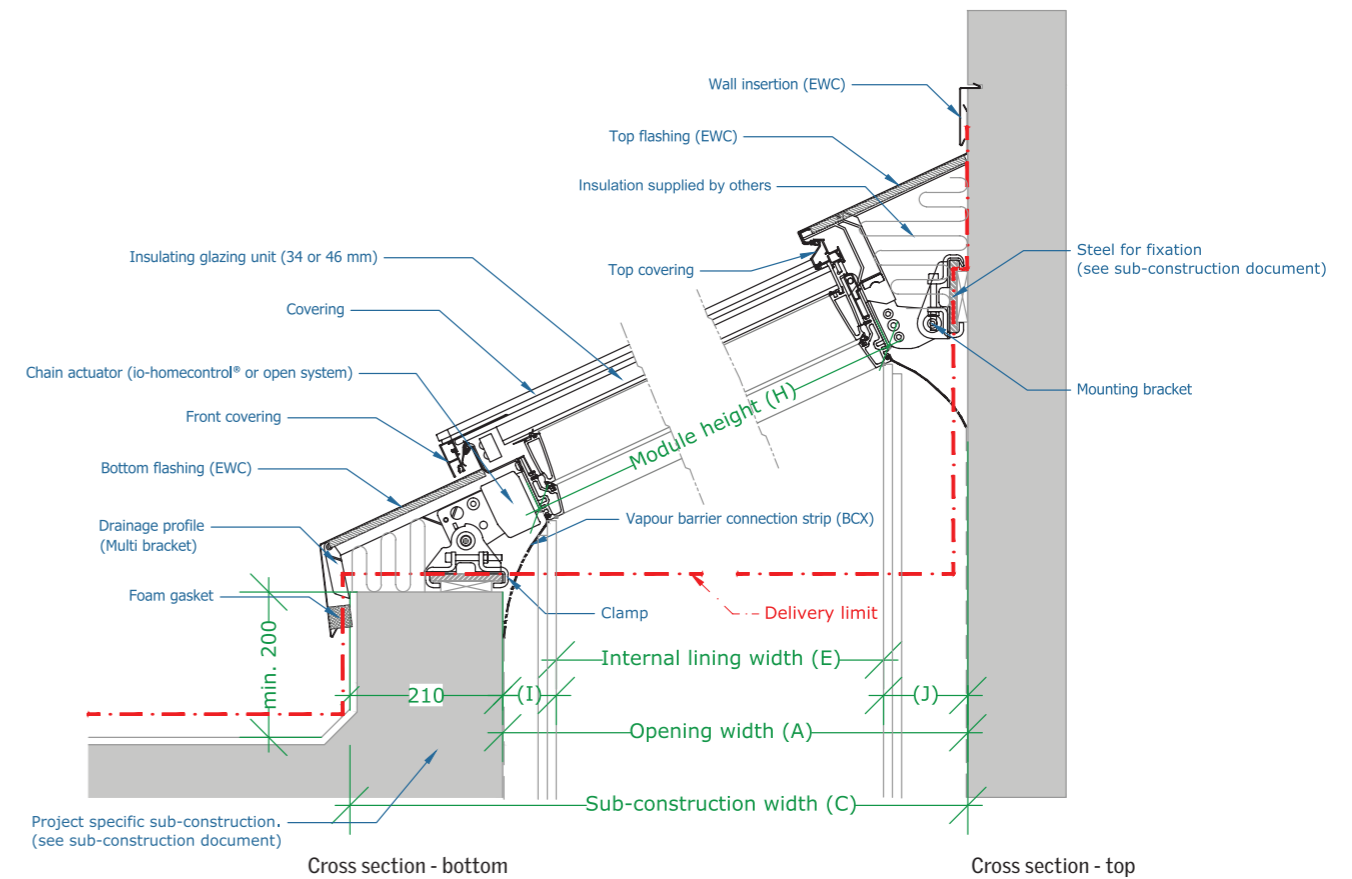

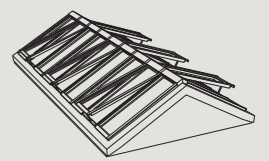

Northlight 25 - 90°

Similar to longlights, northlights are bands of VELUX modular skylights. The characteristic upright design is primarily for installations that are directed towards the northern hemisphere for soft and reflected lighting. Northlight installations are applicable for pitch of 25 to 90°.

At the bottom, Northlights are mounted on a standard steel profile of 100 mm (not a VELUX component) and fixed with clamps holding the skylight in place. At the top the brackets are fixed to the sub construction with screws meant for wood.

The prefabricated modular flashing ensures easy integration in the roof surface. All flashings are easily installed externally, eliminating the need for any interior work. The roof surface underneath the flashing must be appropriate for screw fixation.



Download
CAD & BIM
Objects



Sub-construction for northlight at velux.co.uk/modularskylights

Defining module size to your project

Example:
 $\alpha 1$: H = 1600 mm at installation pitch of 50°

A_{max} = 1680 mm
 A_{min} = 1566 mm

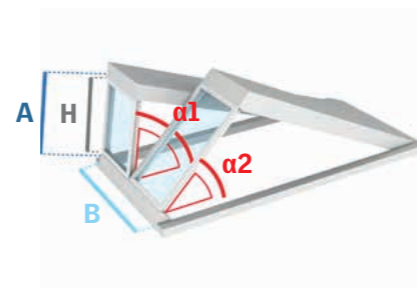

H: Module height
 α : Installation pitch
A: Opening width
B: Opening length

Installation pitch α

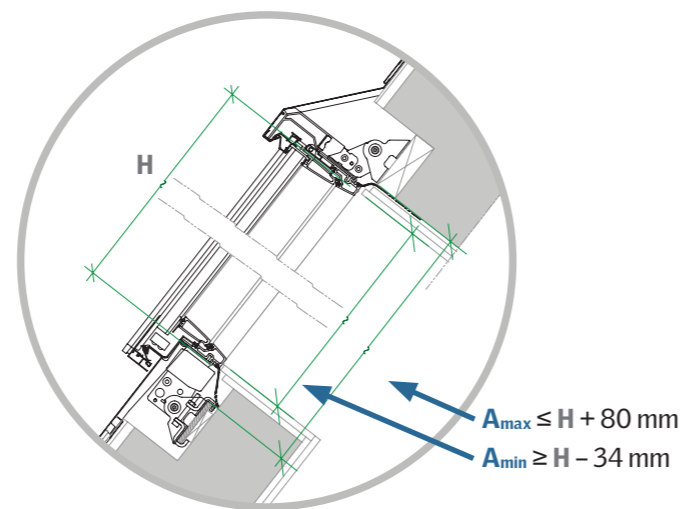
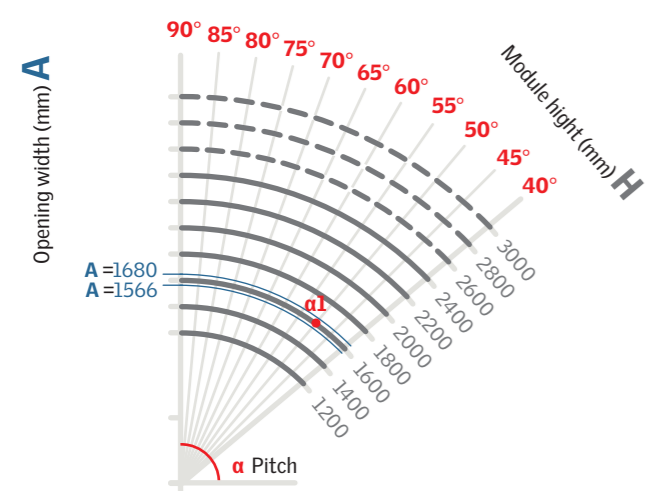

Sectional Drawings

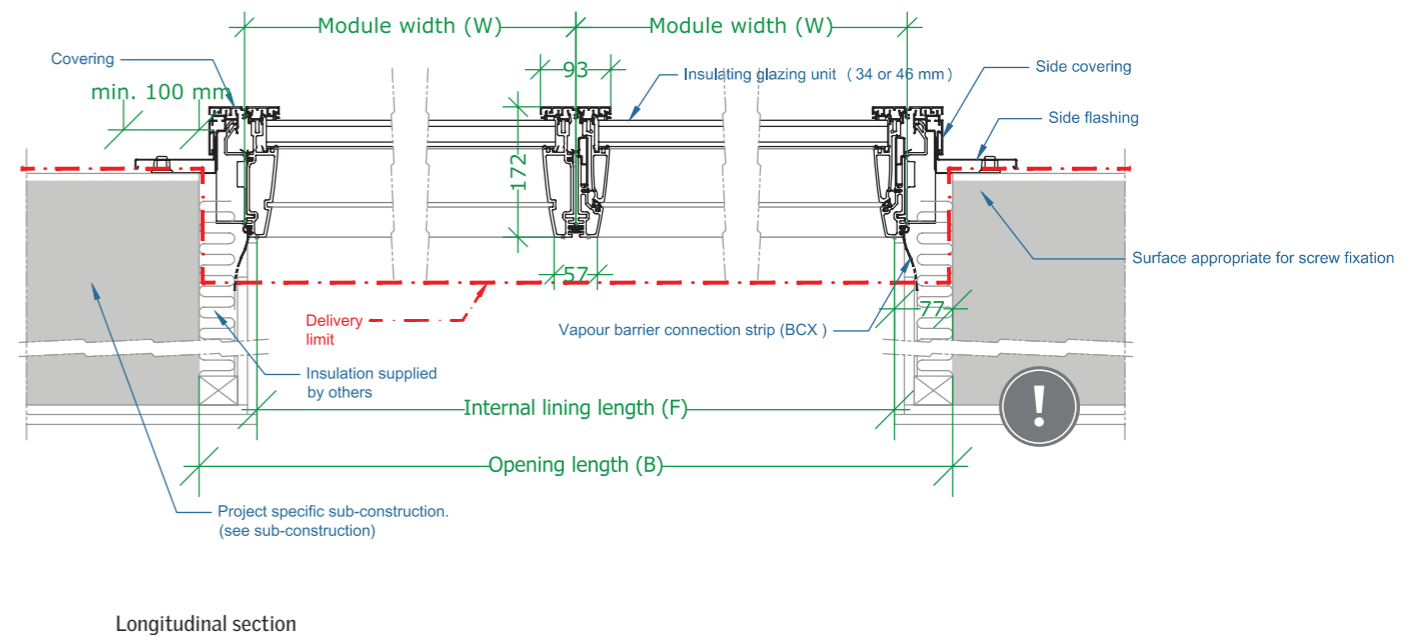
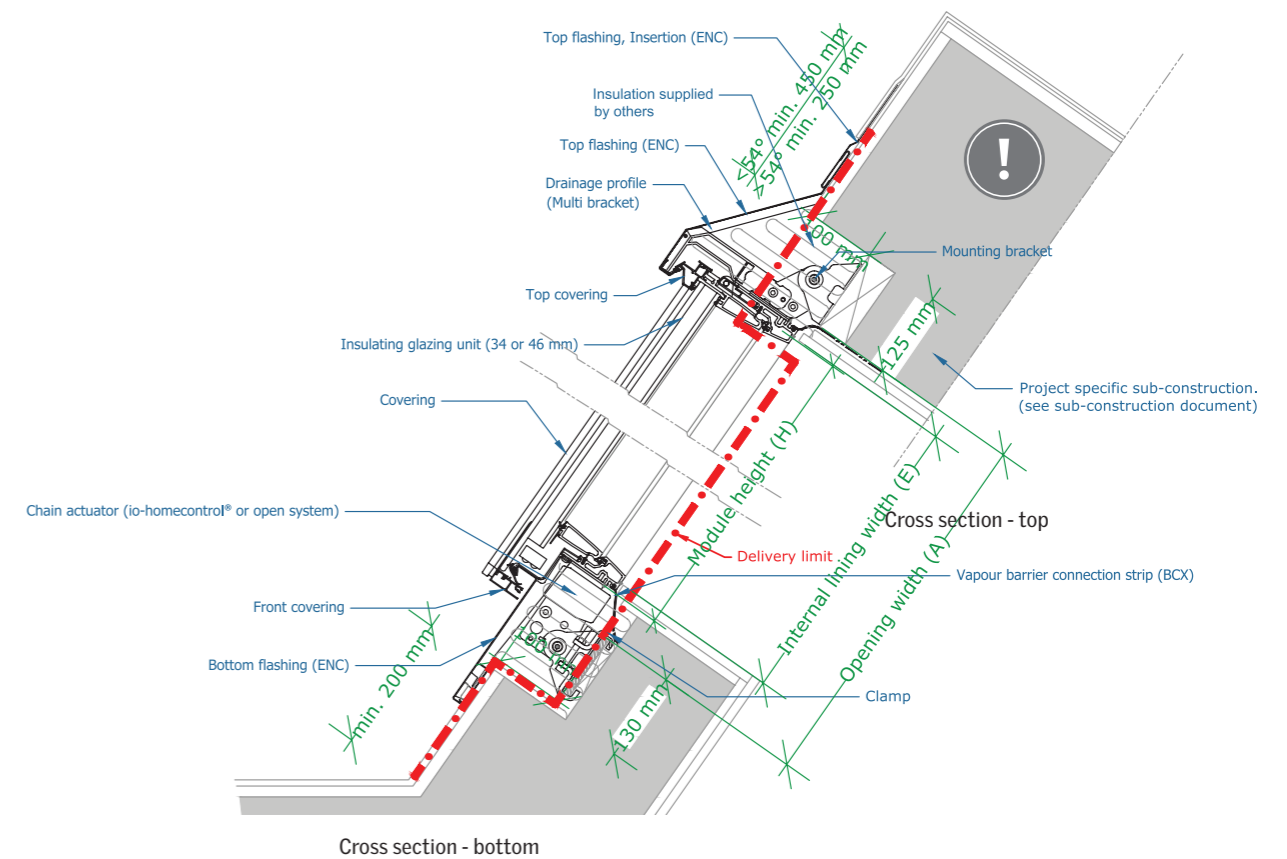

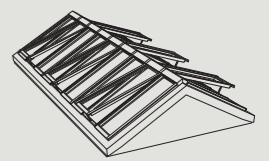

Ridgelight 25 - 40°

Ridgelight is a classic looking solution, consisting of two rows of skylights linked together at the ridge, creating a self-supporting structure. The flashing allows for installations with a pitch of 25 to 40°.

Due to horizontal forces, it is recommended to use a sub-construction of steel or concrete when mounting a ridgelight.

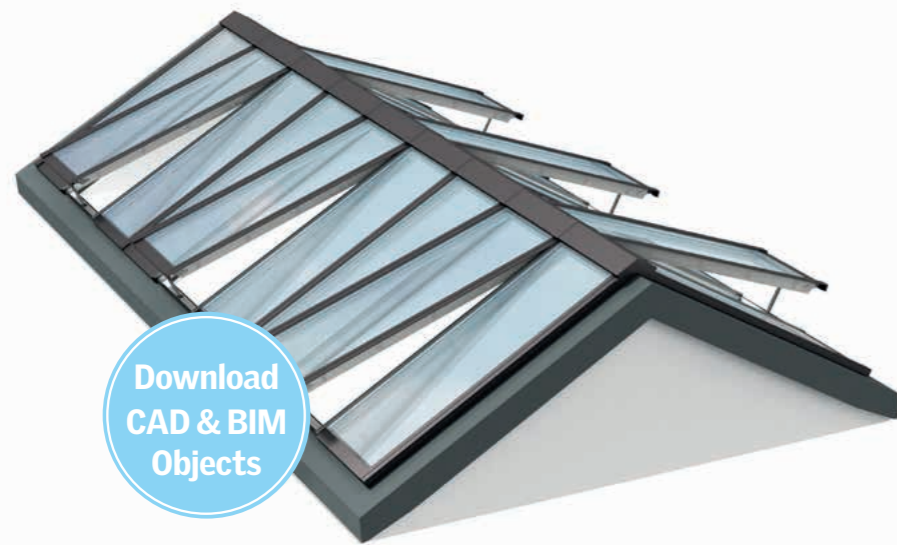

Download
CAD & BIM
Objects

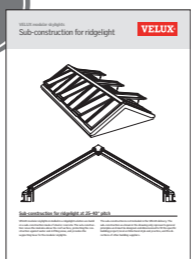

Sub-construction for ridgelight at velux.co.uk/modularskylights

Use the table to define module height (H) and/or installation pitch (α).

Example:
A = 3775 mm

Result:
α1: H = 2000 mm at installation pitch of 26°
or
α2: H = 2200 mm at installation pitch of 35,5°

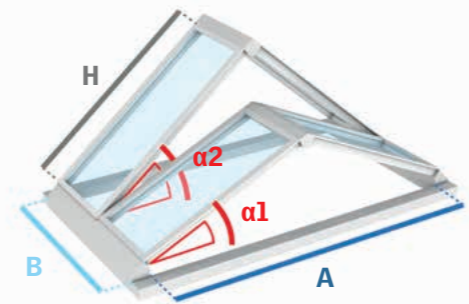

H: Module height
α: Installation pitch
A: Opening width
B: Opening length

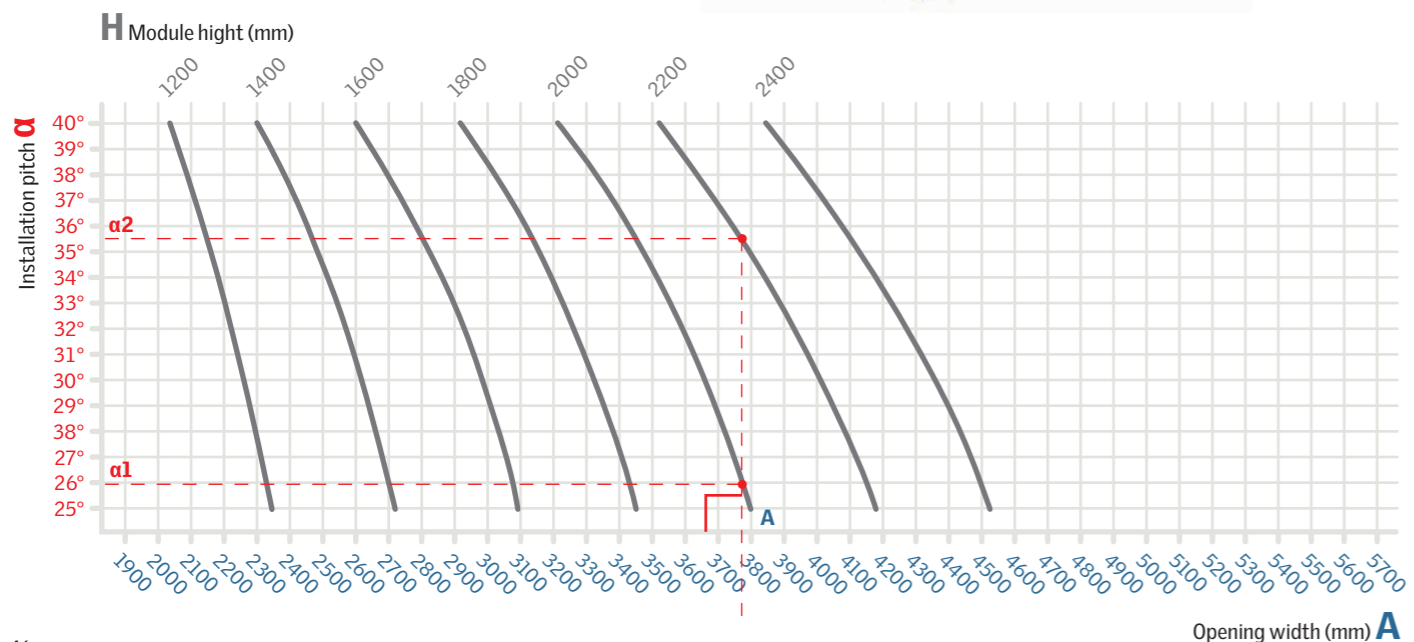

Sectional Drawings

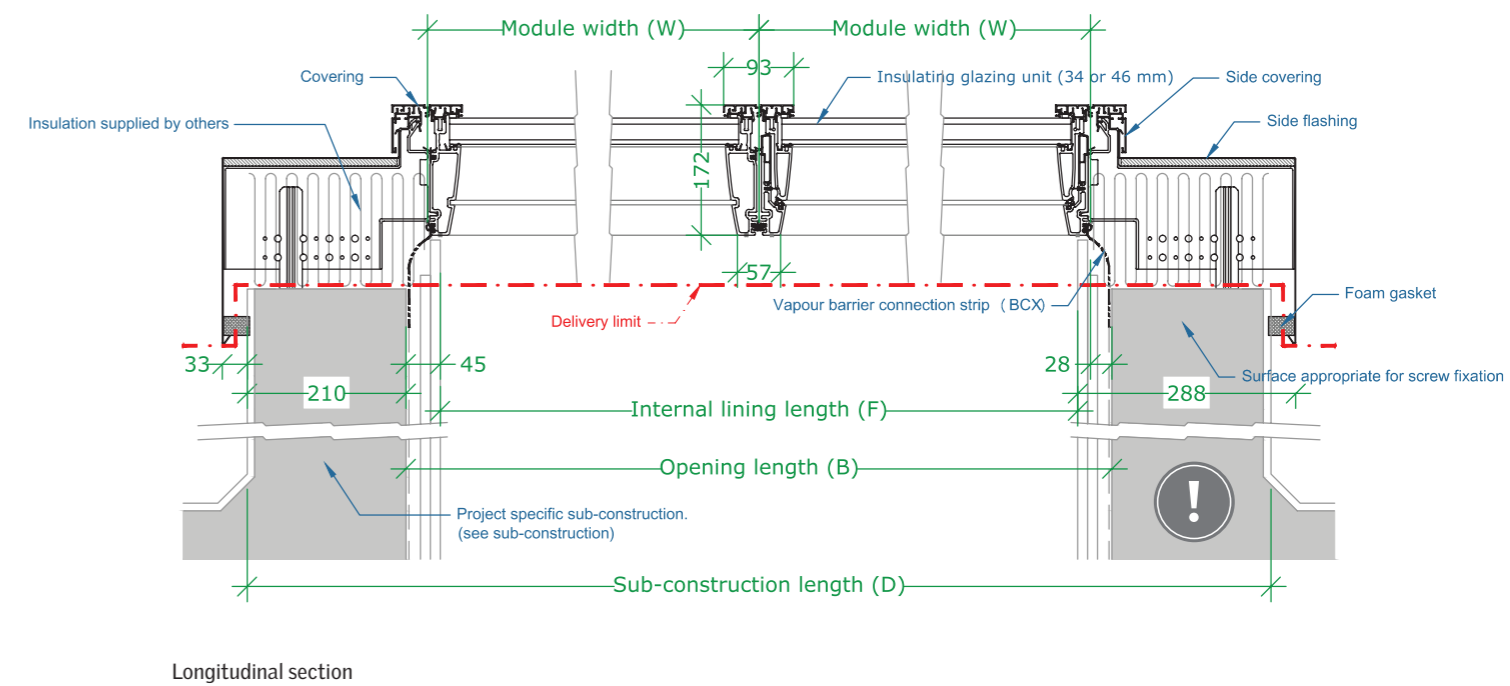
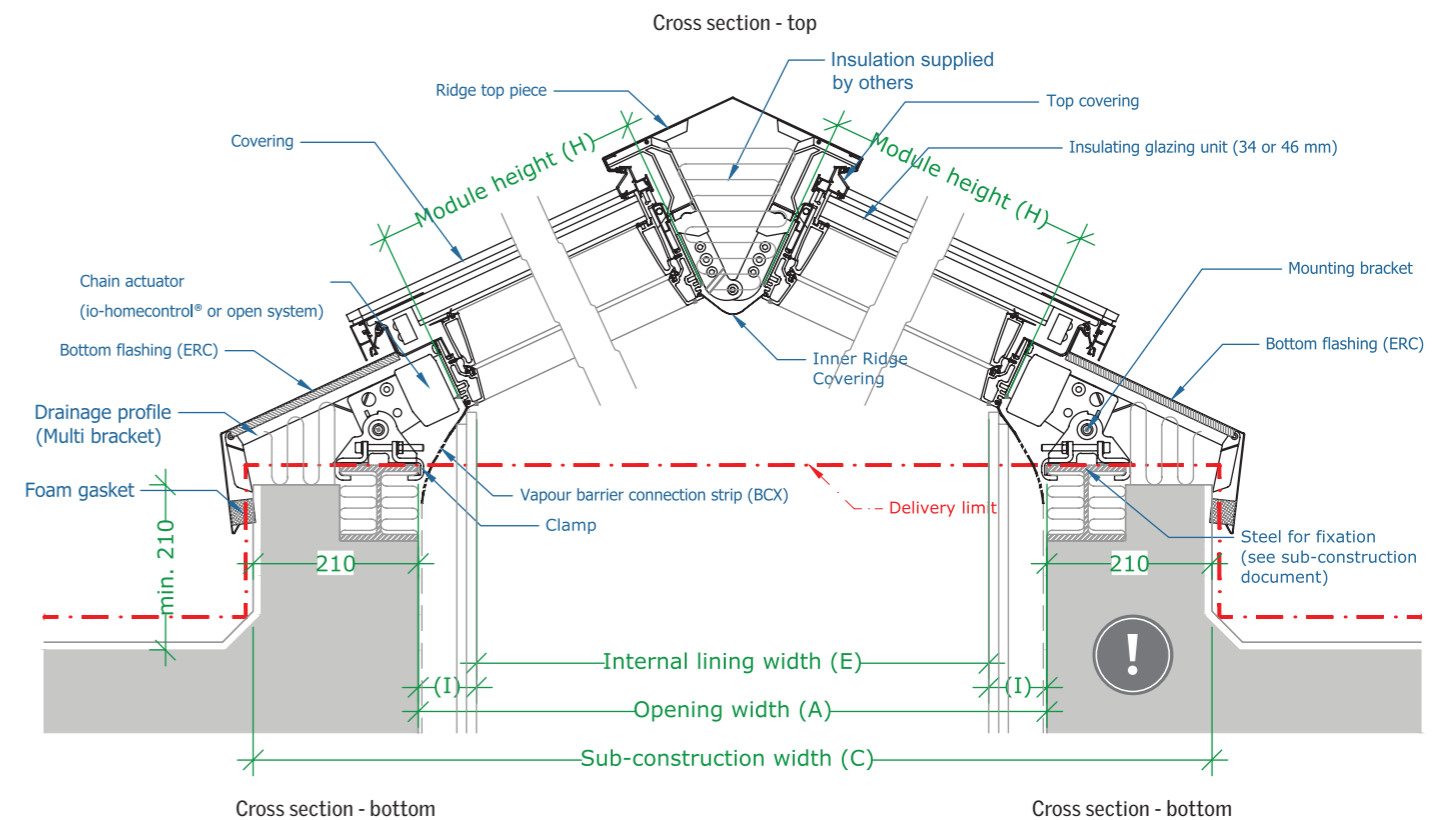

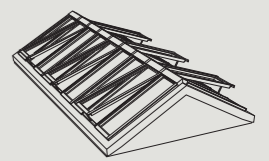

Ridglight at 5° with Beam

Ridglights at 5° pitch guarantee the illusion of a small glass roof with discreet transverse horizontal supporting beams.

The prefabricated VELUX beam supports the skylights and creates the 5° pitch. The beams are mounted on the sub-construction.

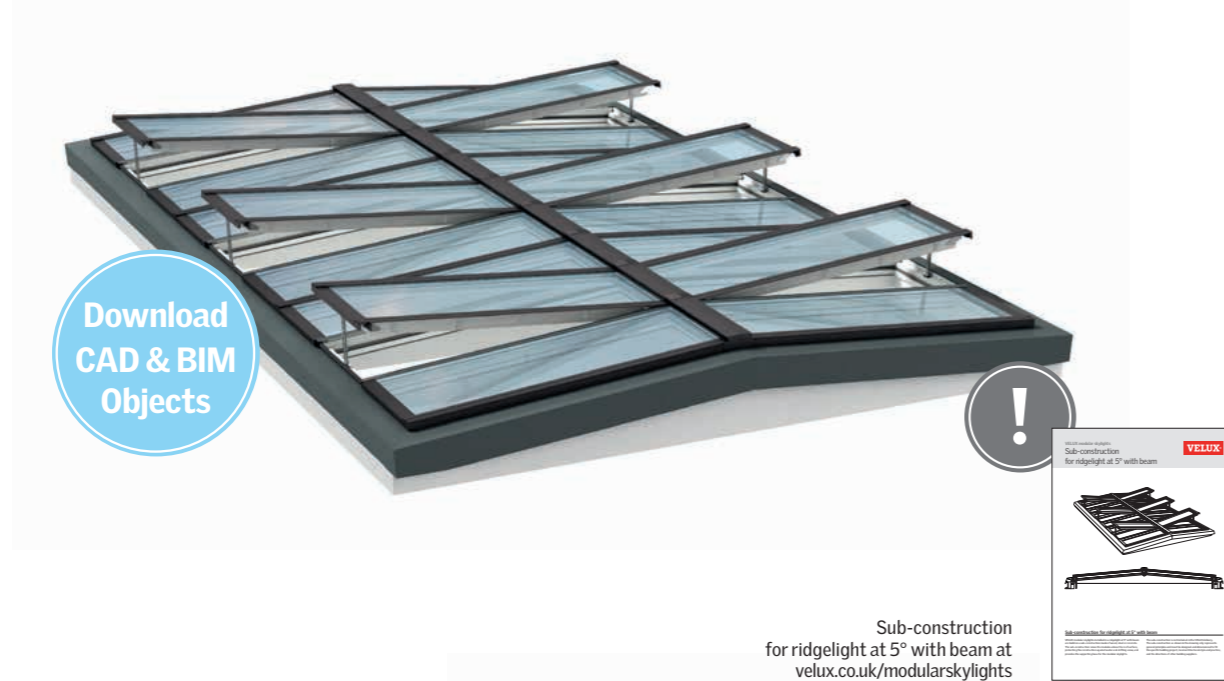

Sub-construction for ridglight at 5° with beam at velux.co.uk/modularskylights

Use the table to define module height (H) and/or installation pitch (α).

Example:
A = 4975 mm

Result:
 α : H = 2400 mm at installation pitch of 5°

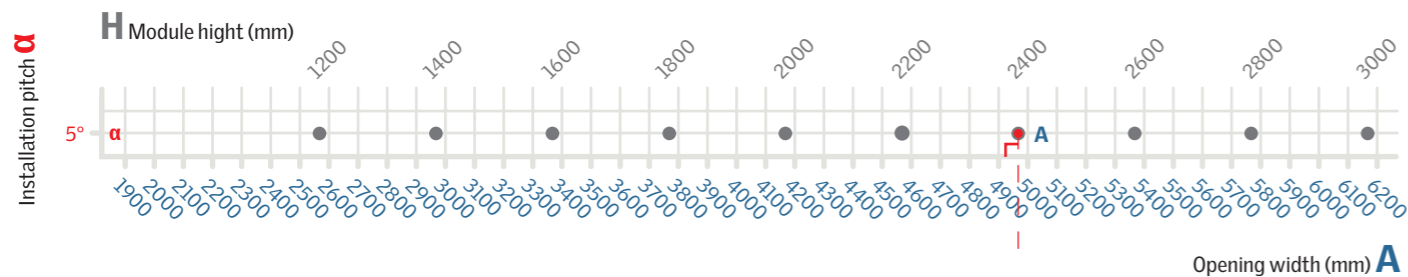
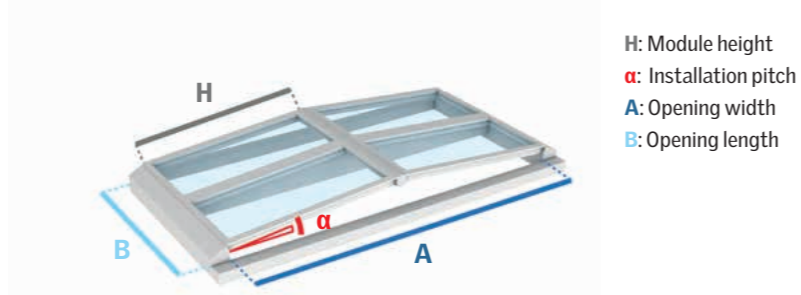

Sectional Drawings

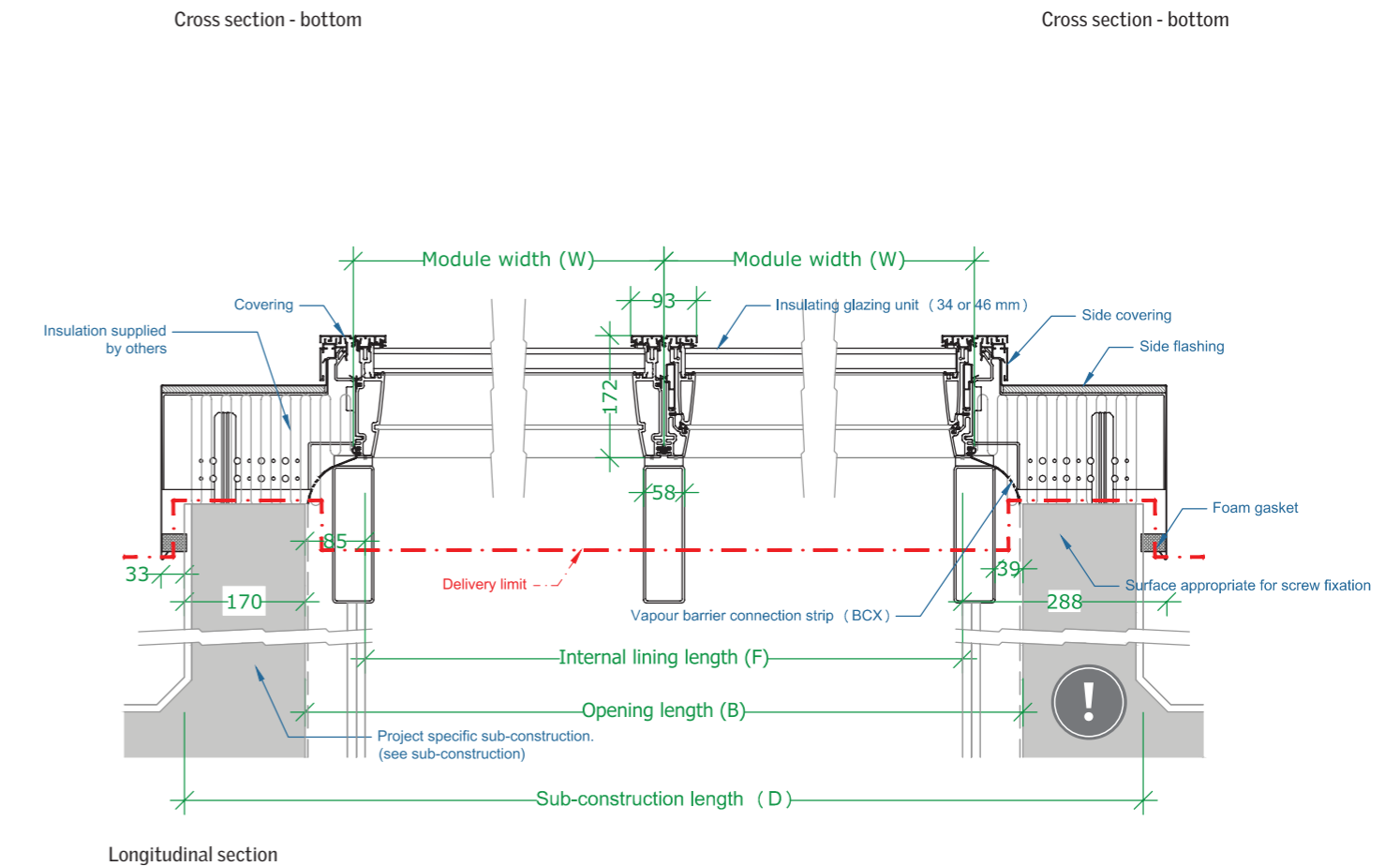
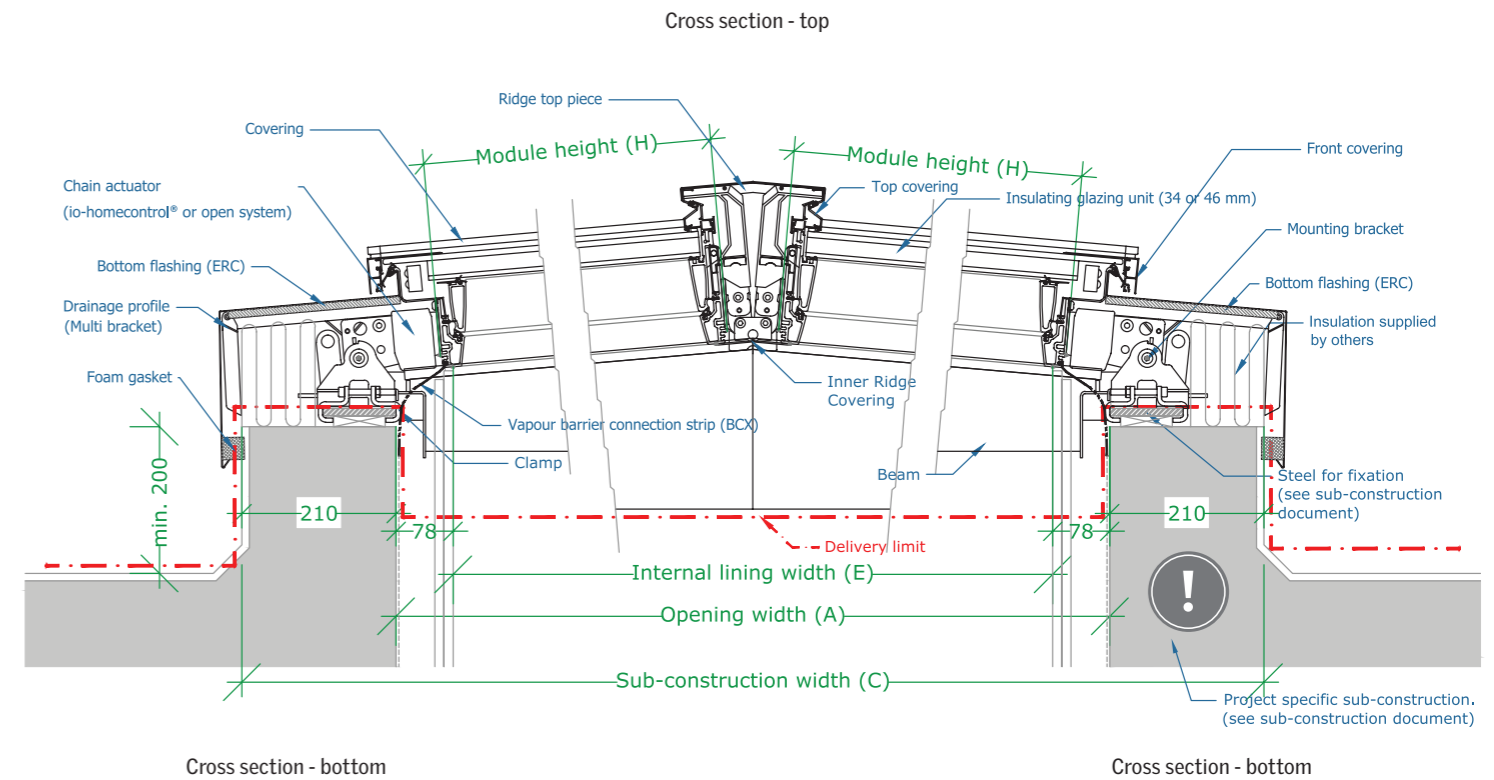

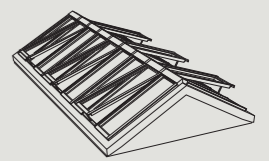

Atrium Longlight

An atrium solution consists of several longlights attached to each other in the sub-construction. A drainage gutter separates each assembly.

The supporting beams are not included in the VELUX delivery. The support structure is part of the primary structure of the building and will have to be designed by a structural engineer.

The distance between the skylights depends on thickness of insulation, width of drainage gutter and pitch of skylights. The shown example of an atrium is designed with 100 mm insulation and a 400 mm wide drainage gutter in a 5° pitch, resulting in a distance between skylights of 820 mm.

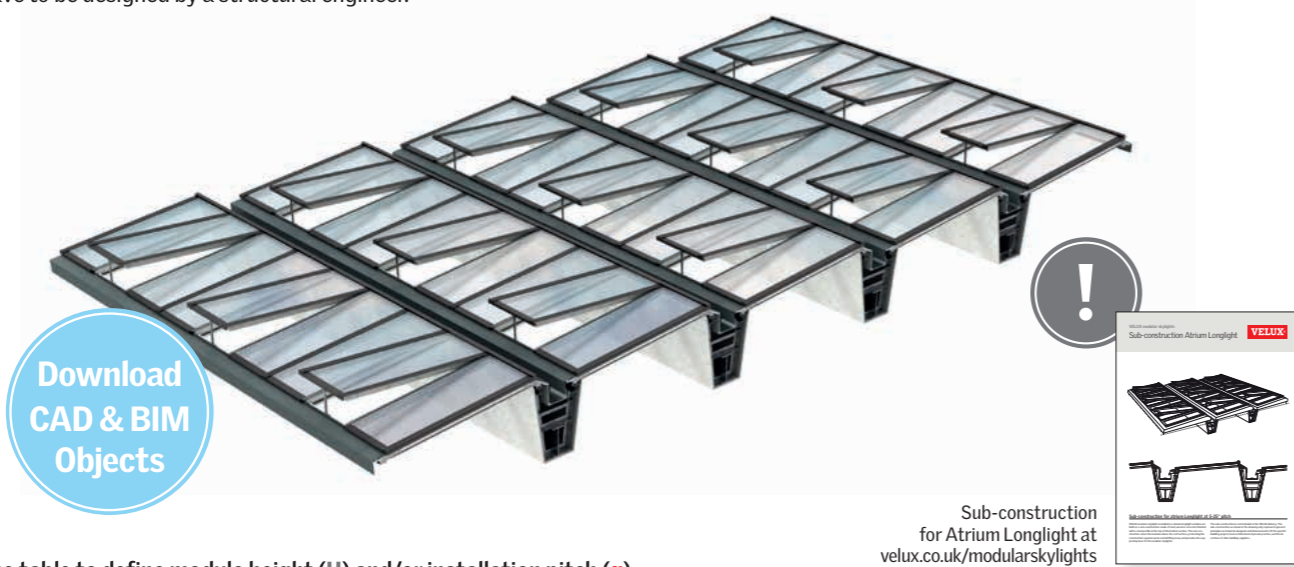

Use the table to define module height (H) and/or installation pitch (α).

Example:
A = 2870 mm

Result:
 α 1: H = 2800 mm at installation pitch of 10°
 or
 α 2: H = 3000 mm at installation pitch of 23°

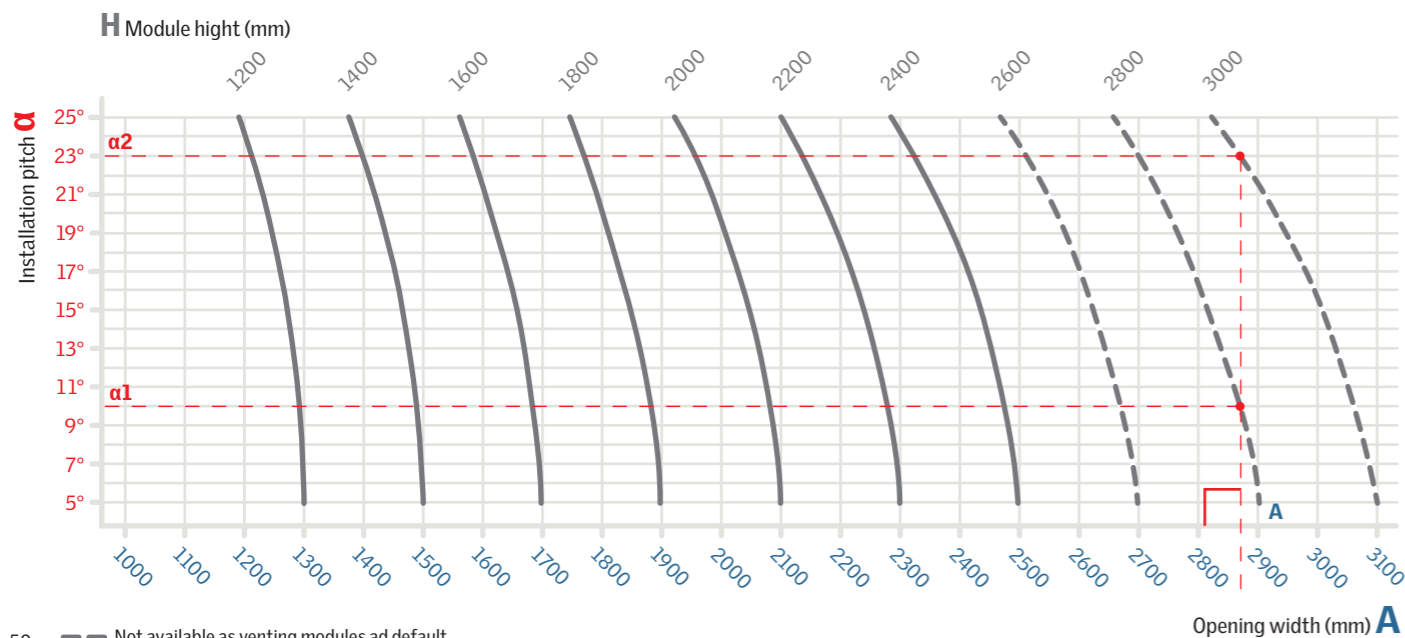
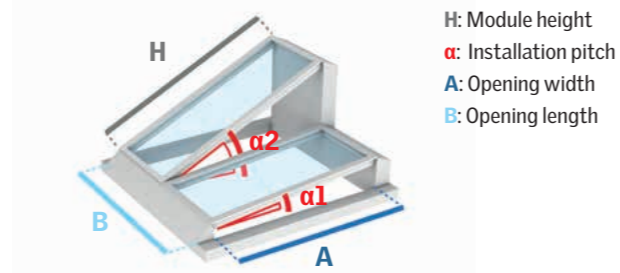

50 — Not available as venting modules ad default. Measurements in the above example are guidelines only. Exact numbers will be supplied by your VELUX sales company.

Sectional Drawings

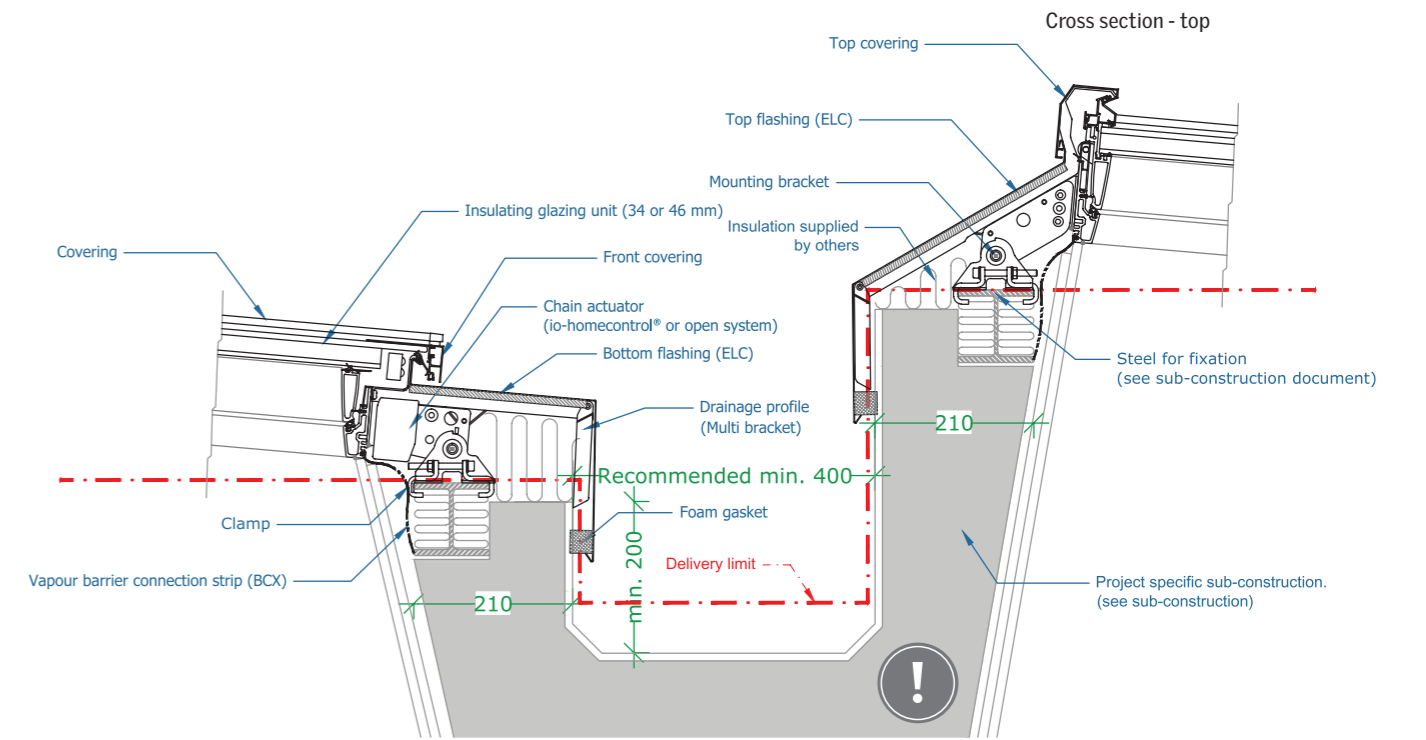

Cross section - bottom

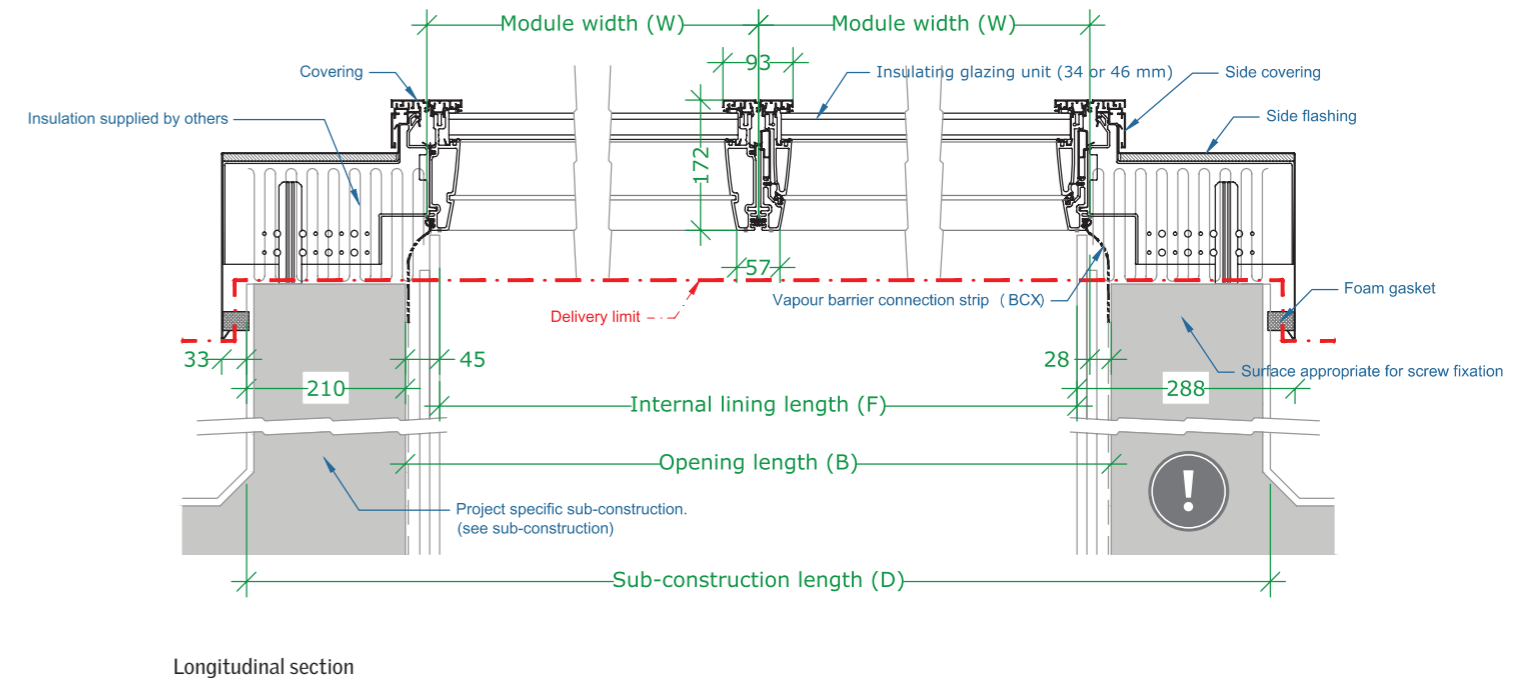

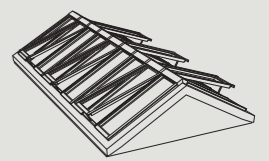

Atrium Ridgelight and Atrium Ridgelight at 5° with Beam

An atrium ridgelight solution consists of several ridgelights attached to each other in the sub-construction. A drainage gutter separates each strip.

The supporting steel beams are not included in the VELUX delivery. The support structure is part of the primary structure of a building and will have to be designed by a structural engineer.

The distance between the skylights depends on thickness of insulation, width of drainage gutter and pitch of skylights. The shown example of an atrium is designed with 100 mm insulation and a 400 mm wide drainage gutter in a 5° pitch, resulting in a distance between skylights of 820 mm.



Download CAD & BIM Objects

Sub-construction for Atrium Ridgelight at velux.co.uk/modularskylights

Use the table to define module height (H) and/or installation pitch (α).

Example:
A = 3775 mm

Result:
α1: H = 1800 mm at installation pitch of 5°
α2: H = 2000 mm at installation pitch of 26°
or
α3: H = 2200 mm at installation pitch of 35.5°

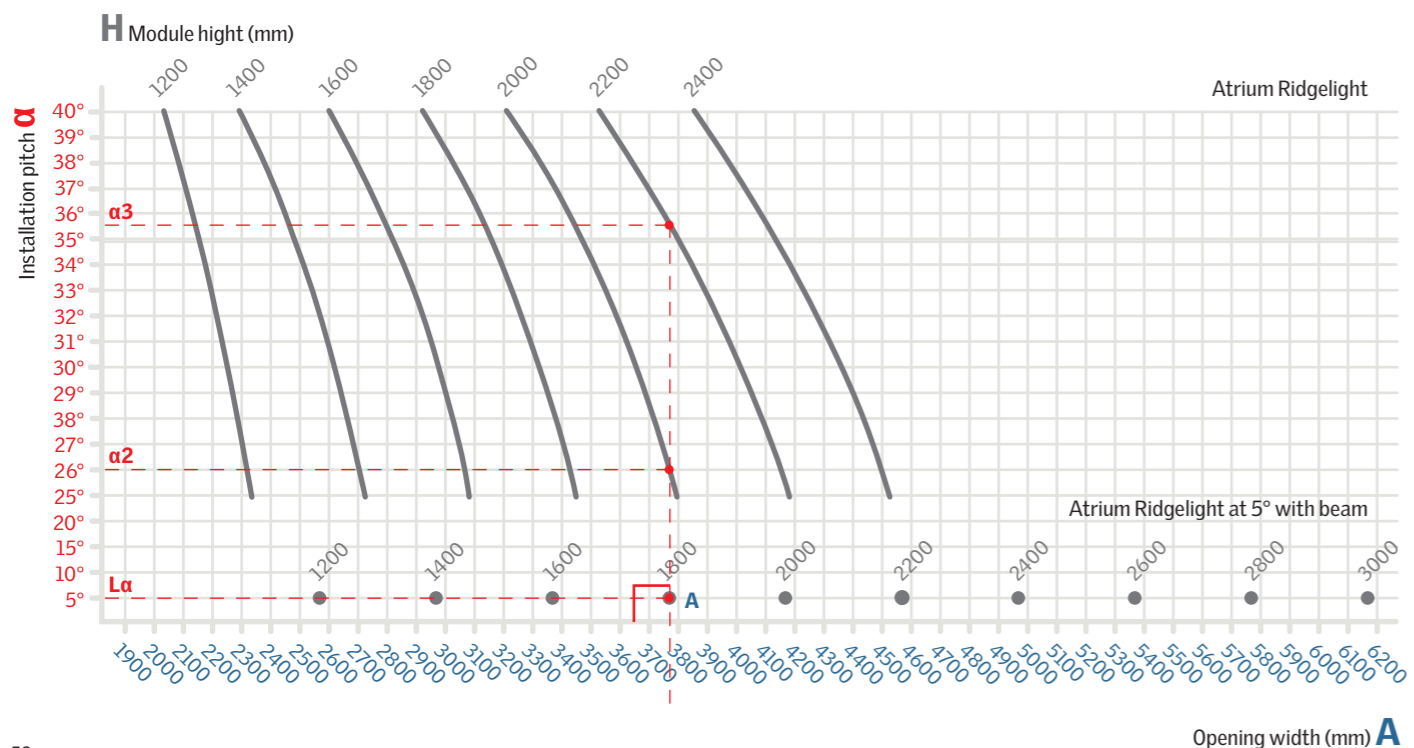

Sectional Drawings

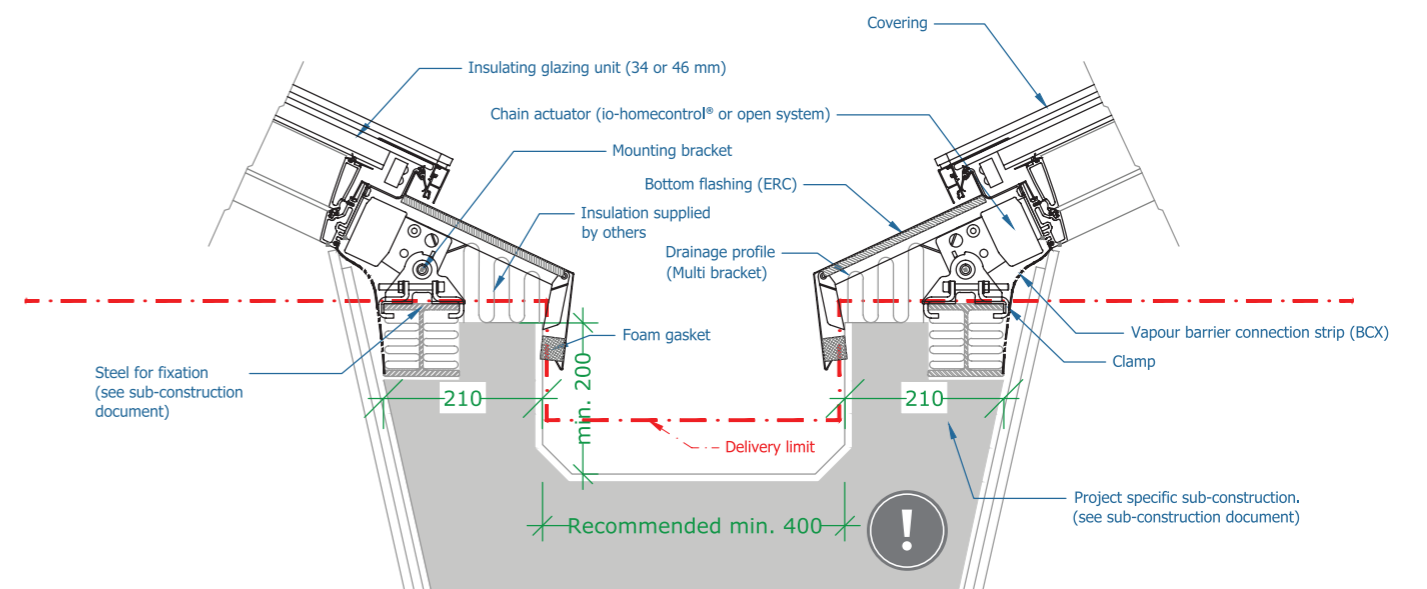

Cross section - bottom

Cross section - bottom

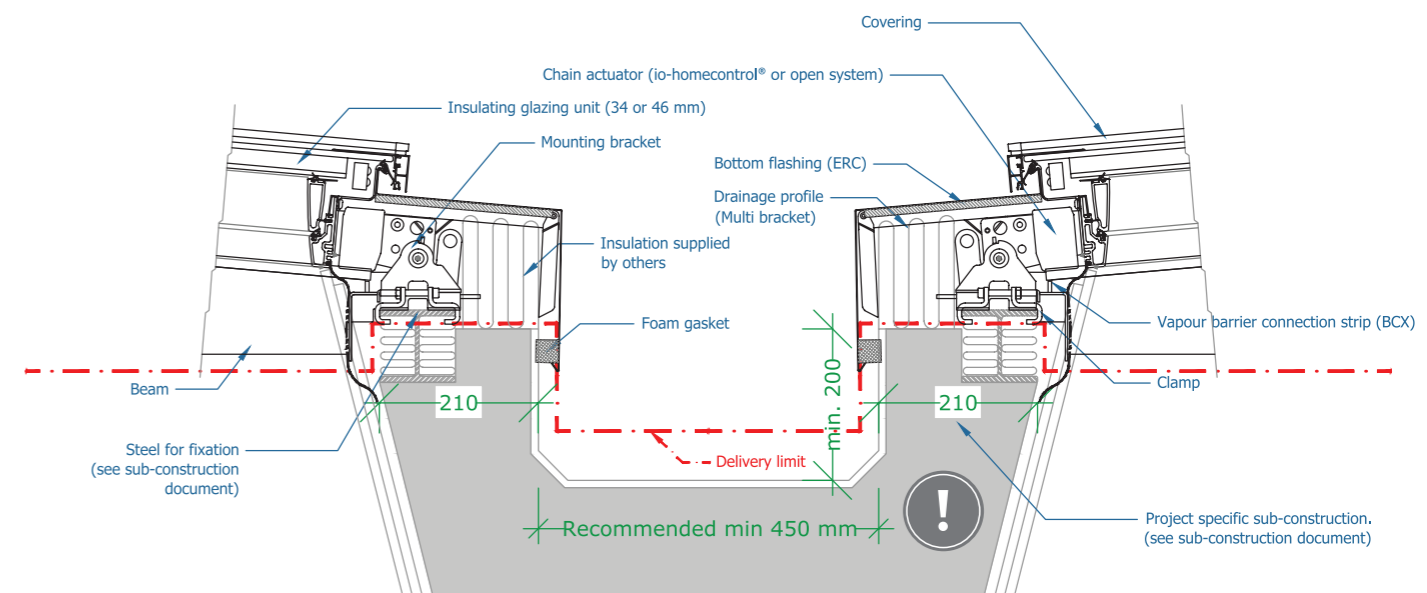

Cross section - bottom

Cross section - bottom

* For longitudinal section drawings for Atrium Ridgelight and Atrium Ridgelight 5° see page 43 and 45.

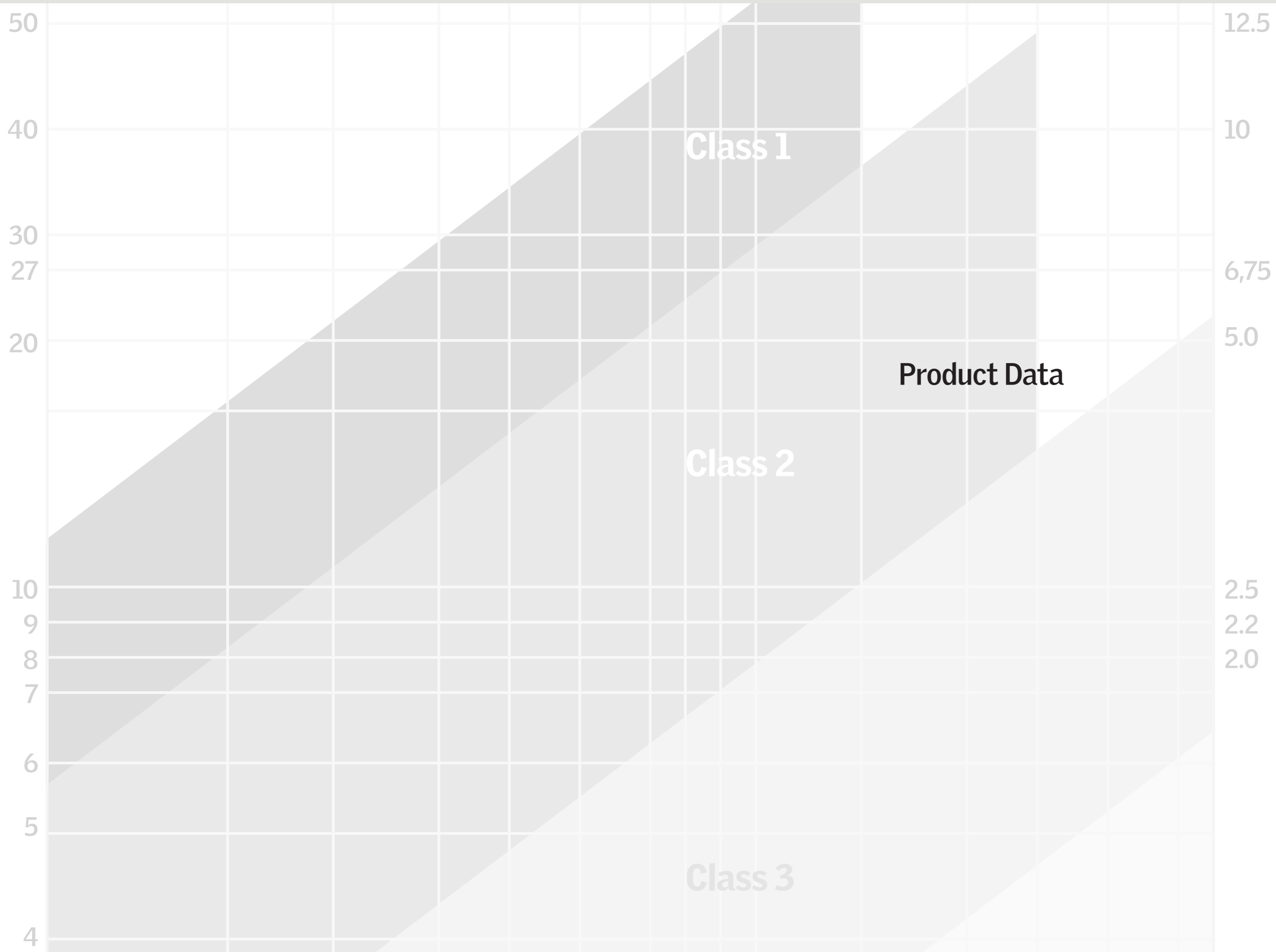

Product Data	
Product Name	Product Code
Product Description	Product Category
Product Dimensions	Product Weight
Product Material	Product Color
Product Features	Product Availability
Product Price	Product Lead Time
Product Warranty	Product Support
Product Contact	Product Website

Skylight Module



Essential characteristic performances for CE-marked skylight modules (EN 14351-1)	
H-C -----	
Essential characteristics	Performance
Resistance to wind load	class C5 ¹⁾
Resistance to snow load	See glazing variant construction
Reaction to Fire*	Class B
External fire performance**	B _{ROOF} (t1) ; B _{ROOF} (t4)
Watertightness***	E900
Impact resistance	NPD
Load-bearing capacity of safety devices	NPD ²⁾
Acoustic performance	35 (-1; -5) - 38 (-1; -4) dB ³⁾
Thermal transmittance	Double glazing: 1,3-1,5 W/m ² K ³⁾ Triple glazing: 0,86-1,1 W/m ² K ³⁾
Solar factor	0,60 - 0,13 ³⁾
Light transmittance	0,79 - 0,16 ³⁾
Air permeability****	class 4

- ¹⁾ For skylight height > 2400 mm: NPD
- ²⁾ No safety device on VELUX modular skylights
- ³⁾ For specific types and sizes see the table with glazing variants on page 66

- * For explanation of test method and results, please refer to section of Reaction to Fire
- ** For explanation of test method and results, please refer to section of External fire performance
- *** For explanation of test method and results, please refer to section of Watertightness
- **** For explanation of test method and results, please refer to section of Air Permeability

Performance of fire resistant skylight modules (EN 13501-2)	
H-S -----	
Essential characteristics	Performance
Resistance to Fire HVS (openable)	EI30
Resistance to Fire HVS (openable)	REI30

Note:
The fire resistant modules are tested in accordance with EN 1365-2 and EN 1634-1. The classifications are expressed in accordance with EN 13501-2. The tests are carried out without roller blinds by default.
If a customer wishes to install roller blinds on the fire resistant modules subsequently, VELUX urges the customers to obtain written approval from the local fire authorities.

Skylight Module

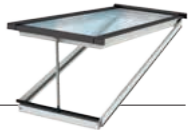

Essential characteristic performances for CE-marked smoke ventilation skylight modules (EN 12101-2)	
H-C -----AB	
Essential characteristics	Performance
Nominal activation system/sensitivity	passed
Response delay (response time)	< 60 s
Operational reliability	Re 1000 + 10 000
Aerodynamic free area (A _s) [m ²]	See ventilation tables on pages 61 and 62
Resistance to heat	B300
Mechanical stability	passed
Opening under load	See tables below (Opening under load)
Low ambient temperature	T(-15)
Stability under wind load	WL 3000
Resistance to wind-induced vibration (where included)	passed
Reaction to fire*	class B**

- * For explanation of test method and results, please refer to section of Reaction to Fire
- ** Variants with inner pane of 55.2 lamination have a sub-class s1-d0
Variants with inner pane of 33.2 and 44.2 lamination have a sub-class s1-d2

Opening under load

Snow load with double-glazing unit (10, 11 and 12)					
With motor force 1300N Total glass thickness 14 mm					
H/W	HVC 067---	HVC 075---	HVC 080---	HVC 090---	HVC 100---
HVC ---080	SL 3533	SL 3179	SL 2976	SL 2632	SL 2351
HVC ---100	SL 2785	SL 2499	SL 2336	SL 2058	SL 1831
HVC ---120	SL 2278	SL 2039	SL 1902	SL 1669	SL 1479
HVC ---140	SL 1912	SL 1706	SL 1588	SL 1388	SL 1224
HVC ---160	SL 1635	SL 1454	SL 1351	SL 1175	SL 1032
HVC ---180	SL 1418	SL 1257	SL 1165	SL 1009	SL 881
HVC ---200	SL 1244	SL 1099	SL 1016	SL 875	SL 760
HVC ---220	SL 1101	SL 969	SL 893	SL 765	SL 660
HVC ---240	SL 981	SL 860	SL 791	SL 673	SL 577
HVC ---260	SL 879	SL 768			
HVC ---280	SL 792				

Snow load with triple-glazing unit (16, 16K, 16T, 17, 17K, 17T, 18 and 18T)					
With motor force 1300N Total glass thickness 22 mm					
H/W	HVC 067---	HVC 075---	HVC 080---	HVC 090---	HVC 100---
HVC ---080	SL 3399	SL 3041	SL 2836	SL 2487	SL 2203
HVC ---100	SL 2646	SL 2356	SL 2190	SL 1908	SL 1678
HVC ---120	SL 2135	SL 1892	SL 1753	SL 1516	SL 1323
HVC ---140	SL 1766	SL 1557	SL 1437	SL 1233	SL 1066
HVC ---160	SL 1487	SL 1303	SL 1198	SL 1018	SL 872
HVC ---180	SL 1269	SL 1105	SL 1011	SL 850	SL 720
HVC ---200	SL 1094	SL 945	SL 860	SL 716	SL 598
HVC ---220	SL 950	SL 814	SL 737	SL 605	SL 497
HVC ---240	SL 829	SL 705	SL 633	SL 512	SL 413
HVC ---260	SL 727	SL 617			
HVC ---280	SL 639				

Snow load with double-glazing unit (10T, 11T and 12T)					
With motor force 1300N Total glass thickness 18 mm					
H/W	HVC 067---	HVC 075---	HVC 080---	HVC 090---	HVC 100---
HVC ---080	SL 3460	SL 3105	SL 2901	SL 2555	SL 2273
HVC ---100	SL 2710	SL 2424	SL 2259	SL 1980	SL 1751
HVC ---120	SL 2203	SL 1962	SL 1824	SL 1590	SL 1398
HVC ---140	SL 1836	SL 1629	SL 1510	SL 1308	SL 1143
HVC ---160	SL 1559	SL 1377	SL 1272	SL 1095	SL 950
HVC ---180	SL 1342	SL 1179	SL 1086	SL 928	SL 799
HVC ---200	SL 1167	SL 1021	SL 937	SL 794	SL 678
HVC ---220	SL 1024	SL 891	SL 814	SL 684	SL 578
HVC ---240	SL 904	SL 782	SL 711	SL 592	SL 495
HVC ---260	SL 802	SL 689			
HVC ---280	SL 715				

The tables illustrate the performance for modules opening under load in accordance with EN 12101-2. The provided performance is NOT equal to structural load bearing capacity of an actual application. The design of a roof light must therefore be dimensioned to fit the specific building project, local architectural style and practice.

Standard size. Special sizes, functional limitations may apply.

Product name	VELUX KCD	Accessories	Accessories
Product code	W00H00 0040	Accessories	Accessories
Material	Aluminium	Accessories	Accessories
Material thickness	3 mm / 6 mm	Accessories	Accessories
Surface treatment	Powder coated (60 - 120µ)	Accessories	Accessories
Colour	NCS S7500-N, gloss 30	Accessories	Accessories

Skylight Module

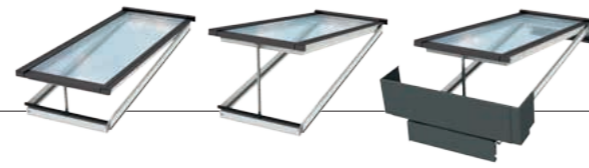

Smoke Ventilation Systems

A smoke ventilation system is always a building specific design, incorporating smoke ventilators, controls, air inlets and mechanical ventilation.

Designing a smoke ventilation system is therefore a rather complex matter, which shall be addressed by skilled and authorized fire engineers, in order to obtain adequate performance and level of safety.

The design cover all relevant parameters such as the location of the building, height and shape of the roof, position of ventilators on the

roof, relative position to each other, facades and doors providing air intake, mechanical ventilation, evacuation plan and escape routes, and the natural and artificial wind obstacles in the surrounding of the building.

The VELUX Group provide the essential performance characteristics' of each individual CE marked VELUX Modular Skylights in accordance with EN 12101-2, but cannot validate the functionality and safety of the full system.

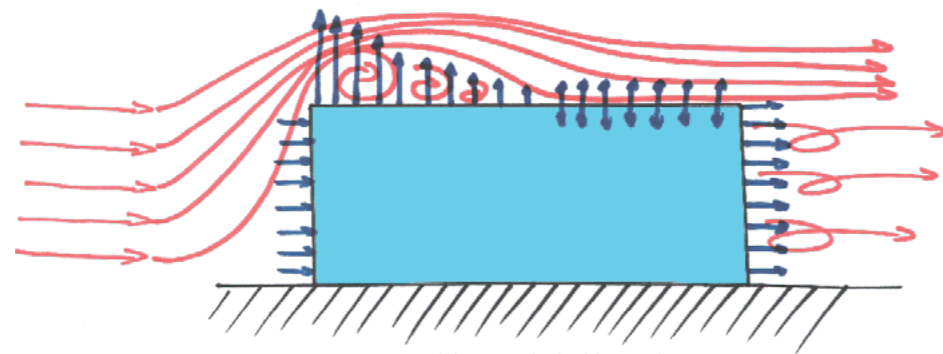

Figur 1: Wind deviation by building (side view)

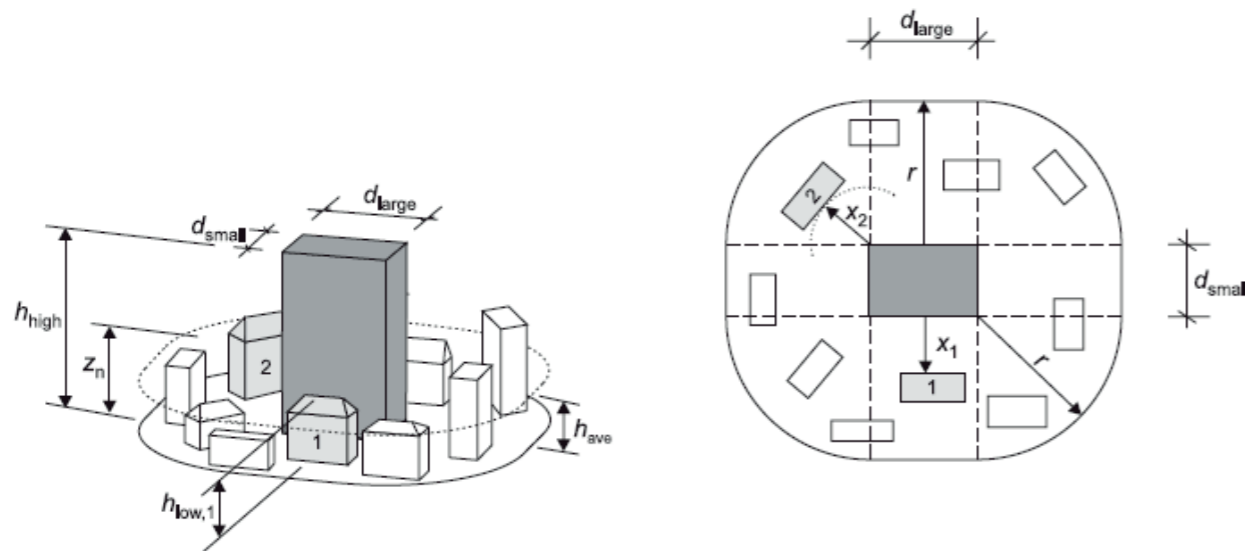

Source of images: DE 611XB549 Rapport, Page 2 Figure 1 and page 11

Skylight Module

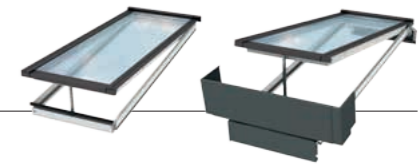

VELUX wind deflector for smoke ventilation modules

Whenever it is required to obtain an Aerodynamic free area (Aa) which is accountable in any wind condition, i.e. considering the possible side wind effect, a possible solution is to install smoke ventilators with prefabricated VELUX KCD wind deflector. The KCD wind deflector is specifically designed to change the wind profile in any wind direction and to ensure that negative pressure i.e. wind suction occurs in the direct surrounding of the opening of the Modular Skylight. This enables smoke exhaust even in case of wind, provided that the entire building and smoke ventilation system is designed appropriately by authorized fire engineers.

The aerodynamic performance of the modular skylights with and without deflector in accordance with EN 12101-2 is expressed on the following page 63.

The KCD wind deflector is not applicable above 60° installation inclination, on so called wall- mounted smoke ventilators. Smoke ventilators installed in this range are to be considered wind sensitive by default in accordance with EN 12101-2. When a smoke ventilator is

wind sensitive the Aerodynamic area must be tested and expressed without influence of side wind, therefore the use of a smoke deflector is meaningless.. KCD wind deflector furthermore is not compatible with Northlight flashings, therefore not applicable on Northlight applications.

VELUX smoke ventilation modular skylights can be used without wind deflector, when local regulations and design conditions are allowing to do so. When VELUX smoke ventilator modular skylights are installed without deflectors they are wind sensitive, which means that negative discharge i.e. air intake may occur in unfavorable wind conditions. This must be regarded and addressed by the building owner when designing the building and planning with wind sensitive smoke ventilators. To prevent negative discharge the building owner must take steps to incorporate the product as a part of the total solution that can be approved by the local authorities. The sound could be, for instance a wind direction sensor in connection with multi-direction placement of smoke ventilators or a KCD wind deflector, or another device/roof integrated solution that ensures a sufficient aerodynamic free area.

Wind deflector KCD W00H00 0040

Material	Aluminium
Material thickness	3 mm / 6 mm
Surface treatment	Powder coated (60 - 120µ)
Colour	NCS S7500-N, gloss 30



VELUX Modular Skylight Performance Data			
Model	Area [m²]	Weight [kg]	Wind Load [kN/m²]
HVC 090100 0010AB	0,36	12	0,5
KCD W00H00 0040	0,19	6	0,5

Examples

Skylight: HVC 090100 0010AB
 Aerodynamic Free Area (Aa) without deflector*: 0,36 m²
 Aerodynamic Free Area (Aa) with wind deflector KCD W00H00 0040: 0,19 m²
 Required Total Aerodynamic area: 4 m²

Example 1.

Wind influence can be disregarded based on local conditions and regulations
 Skylight: HVC 090100 0010AB - Aerodynamic Free Area (Aa) without deflector*: 0,36 m²
 Number of required skylights: 4 m² / 0,36 m² = 11.111 → 12 units

Example 2.

Wind influence must be regarded based on local conditions and regulations
 Skylight: HVC 090100 0010AB
 Aerodynamic Free Area (Aa) without deflector*: 0,36 m²
 Aerodynamic Free Area (Aa) with wind deflector KCD W00H00 0040: 0,19 m²

Solution 1

Skylights placed in 4 different directions and wind direction dependent opening control used to avoid opening of skylights facing to unfavorable wind
 Number of required skylights: 4 m² x 4 = 16 m² / 0,36 m² = 44,444 → 45 units

Solution 2

Use KCD wind deflector
 Number of required skylights: 4 m² / 0,19 m² = 28,571 → 29 → 22 units

Alternative solution

Example 1 might also be possible with the condition that a wind barrier as a part of the roof construction is designed and built by the project in the vicinity of the skylights. The design of course has to be approved by the local authorities as sufficient solution to protect the smoke ventilation skylights from the impact of unfavorable wind.

Definitions

In accordance with EN 12101-2:

C_v [-] Coefficient of discharge that states the ratio between Aa and A_v (C_v = A_a/A_v). For roof-mounted smoke and heat exhaust ventilators the value of C_v is the lower of C_{v0} and C_{v_w}. For wall-mounted smoke and heat exhaust ventilators C_v is not to be tested with wind influence i.e. C_v = C_{v0}.

C_{v0} [-] Coefficient of discharge calculated based on pressure testing without side wind influence.

C_{v_w} [-] Coefficient of discharge calculated based on pressure testing with side wind influence.

A_a [m²] A_a [m²] Aerodynamic free area (A_a = A_v x C_v). May be described as the effective area of the ventilator taking into account reductions in air flow along edges and around the openable panel as well as motors etc.

A_v [m²] Geometric area, corresponds to frame aperture area.

Roof-mounted:

Smoke ventilators installed from 0° up to 60°. VELUX Modular Skylights installed from 5° to 60° are proven wind sensitive. This must be considered in planning the smoke ventilation of the building.

Wall-mounted:

Smoke ventilators installed above 60° up to 90°. Wall-mounted smoke ventilators are, as per definition, wind sensitive regardless form the design.

Other relevant parameters

In accordance with DIN 18232

A_g [m²] Geometric free area, corresponds to the minimum unobstructed opening area of the smoke ventilators.

The area is calculated by the use of the total opening area of the ventilator, in case of Modular Skylight top-hung ventilators from the front opening and the side triangles. Not identical to **A_c [m²]**, which is calculated in comfort opening position.

The use of the parameter is to define the ventilation area of smoke ventilators when they are used as so called smoke exhaust shaft, assuming that outtake pressure is generated by mechanical extract fans or generated by chimney stack effect. A typical use of this area is when smoke ventilators are used over staircases. National and local regulations may differ and wherever they exist must be followed.

In accordance with EN 13141-1

A_c [m²] Geometric free area, corresponds to the minimum unobstructed opening of the openable modular skylights in natural comfort ventilation position.

The area is calculated by the use of the total opening area of the ventilator, in case of Modular Skylight top-hung ventilators from the front opening and the side triangles. Not identical to **A_g [m²]**, which is calculated in smoke ventilation opening position.

Used to define natural ventilation performance of comfort ventilation modular skylights and dual purpose smoke ventilation modular skylights in comfort ventilation use.

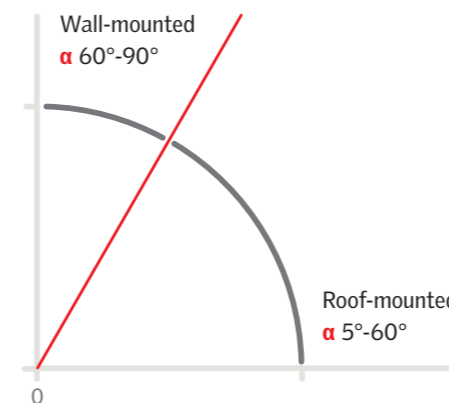

Product	VELUX	Model	AB
Material	Aluminum	Color	Black
Weight	15 kg	Height	100 mm
Length	675 mm	Width	800 mm
Area	0.54 m ²	Volume	0.054 m ³
Installation	Roof	Orientation	Horizontal
Accessories	Deflector	Actuator	Chain
Compliance	EN 12101-2	EN 13141-1	DIN 18232

Skylight Module



Comfort ventilation

Geometric free area: A_c [m²]

In accordance with EN 13141-1



Smoke ventilation

Geometric area: A_v [m²]

In accordance with EN 12101-2



Smoke ventilation

Geometric free area: A_g [m²]

In accordance with DIN 18232

Skylight Module



Size of Skylights	Smoke ventilation characteristics HVC-----AB												Comfort Ventilation (EN13141-1)			
	Actuator chain stroke [mm]	Opening angle	Geometric area: A_v [m ²]	Discharge coefficient (C_v) (EN 12101-2)				Aerodynamic free area (A_a) (EN 12101-2)				DIN 18232 ⁴⁾	HVC-----B and HVC-----AB in comfort function			
				Without deflector		With Deflector KCD 000040		Without deflector		With deflector type KCD W00H00 0040			Geometric free area: A_g [m ²]	Actuator chain stroke [mm]	Opening angle	Geometric free area: A_c [m ²]
				without side wind	with side wind	without side wind	with side wind	5° ≤ installation inclination ≤ 60°		installation inclination > 60°						
				C_{v0}	C_{vw}	C_{v0}	C_{vw}	$A_{a, Roof}^{1)}$ without side wind ²⁾	$A_{a, Roof}$ with side wind	$A_{a, Wall}^{3)}$	$A_{a, Roof}$ with side wind					
675 x 800	353	25,0°	0,48	0,42	0,00	0,40	0,26	0,20	0,00	0,20	0,13	0,28	353	25,0°	0,28	
675 x 1000	410	23,0°	0,61	0,44	0,00	0,40	0,24	0,27	0,00	0,27	0,15	0,40	410	23,0°	0,40	
675 x 1200	410	19,5°	0,74	0,40	0,00	0,38	0,22	0,30	0,00	0,30	0,16	0,44	410	19,5°	0,44	
675 x 1400	410	16,5°	0,87	0,36	0,00	0,35	0,20	0,31	0,00	0,31	0,17	0,48	410	16,5°	0,48	
675 x 1600	410	14,5°	1,00	0,33	0,00	0,33	0,19	0,33	0,00	0,33	0,19	0,52	410	14,5°	0,52	
675 x 1800	410	13,0°	1,12	0,34	0,00	0,34	0,19	0,38	0,00	0,38	0,21	0,56	410	13,0°	0,56	
675 x 2000	410	11,5°	1,25	0,32	0,00	0,33	0,16	0,40	0,00	0,40	0,20	0,60	410	11,5°	0,60	
675 x 2200	410	10,5°	1,38	0,31	0,00	0,32	0,17	0,43	0,00	0,43	0,23	0,64	410	10,5°	0,64	
675 x 2400	410	9,5°	1,51	0,29	0,00	0,30	0,16	0,44	0,00	0,44	0,24	0,69	410	9,5°	0,69	
675 x 2600	410	9,0°	1,64	0,31	0,00	0,32	0,17	0,50	0,00	0,50	0,28	0,73	410	9,0°	0,73	
675 x 2800	410	8,0°	1,76	0,28	0,00	0,31	0,18	0,49	0,00	0,49	0,32	0,77	410	8,0°	0,77	
750 x 800	353	25,0°	0,54	0,41	0,00	0,38	0,26	0,22	0,00	0,22	0,14	0,30	353	25,0°	0,30	
750 x 1000	439	25,0°	0,68	0,46	0,00	0,40	0,24	0,31	0,00	0,31	0,16	0,47	410	23,0°	0,42	
750 x 1200	460	21,5°	0,83	0,44	0,00	0,41	0,23	0,36	0,00	0,36	0,19	0,56	410	19,5°	0,47	
750 x 1400	460	18,5°	0,97	0,39	0,00	0,38	0,22	0,38	0,00	0,38	0,21	0,61	410	16,5°	0,51	
750 x 1600	460	16,0°	1,11	0,37	0,00	0,36	0,21	0,41	0,00	0,41	0,23	0,66	410	14,5°	0,55	
750 x 1800	460	14,5°	1,25	0,36	0,00	0,35	0,19	0,45	0,00	0,45	0,24	0,71	410	13,0°	0,59	
750 x 2000	460	13,0°	1,40	0,37	0,00	0,35	0,19	0,52	0,00	0,52	0,27	0,76	410	11,5°	0,63	
750 x 2200	460	12,0°	1,54	0,37	0,00	0,36	0,19	0,57	0,00	0,57	0,29	0,81	410	10,5°	0,67	
750 x 2400	460	11,0°	1,68	0,35	0,00	0,35	0,15	0,59	0,00	0,59	0,25	0,86	410	9,5°	0,71	
750 x 2600	460	10,0°	1,83	0,33	0,00	0,33	0,16	0,60	0,00	0,60	0,29	0,90	410	9,0°	0,75	

¹⁾ External building surfaces with inclination of 60° or less relative to the horizontal; shed roofs and continuous roof-lights, independent of inclination angle, are considered to be part of the roofs.

²⁾ The aerodynamic area has been declared in accordance with EN 12101-2, which means the products have been tested with and without side wind. The aerodynamic area expressed without deflector is wind sensitive which therefore, in connection with the design of the smoke ventilation system, means that steps must be taken to incorporate the products as part of a total solution that can be approved by the local fire authorities. This solution could consist of, for instance, a wind direction sensor, a wind deflector or another device that ensures a sufficient aerodynamic area at all times. It is the responsibility of the building owner – together if necessary with the local fire authorities – to ensure the system is specified, installed and operated in accordance with current national legislation and requirements.

³⁾ External building surfaces with an inclination of more than 60° relative to the horizontal.

⁴⁾ Please read page 61.

Product	Velux	Model	...
Material
Weight
Dimensions
...

Glazing Unit

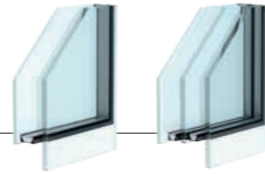

Double Glazing = DG Triple Glazing = TG

TG/ DG	Coating	Pane specification	IGU	Thermal transmittance U _g	Psi value ψ	Thermal transmittance of the entire window in accordance with EN 14351-1		Light transmittance τ _v	Solar factor g	UV transmission τ _{uv}
						area > 2,3 m ²	area ≤ 2,3 m ²			
						U _w	U _w			
Construction (outside - inside)			code	W/m ² K	W/mK	W/m ² K	W/m ² K	%	%	%
DG	LowE	8H-20 Argon-33.2 LowE	10	1,1	0,066	1,4	1,5	79	59	1,6
	Sun1	8H Sun1-20 Argon-33.2	11	1,1	0,066	1,4	1,5	49	27	0,3
	Sun2	8H Sun2-20 Argon-33.2	12	1,1	0,066	1,4	1,5	18	16	0,4
TG	LowE	8H LowE-12 Argon-8HS-12 Argon-33.2F LowE	16	0,7	0,080	1,0	1,1	70	50	1,2
	Sun1	8H Sun1-12 Argon-8HS-12 Argon-33.2F LowE	17	0,7	0,080	1,0	1,1	44	25	0,6
	Sun2	8H Sun2-12 Argon-8HS-12 Argon-33.2F LowE	18	0,7	0,080	1,0	1,1	16	14	0,3
DG	LowE	8H-16 Argon-55.2 LowE	10T	1,0	0,066	1,3	1,4	67	49	0,4
	Sun1	8H Sun1-16 Argon-55.2	11T	1,0	0,066	1,3	1,4	48	27	0,3
	Sun2	8H Sun2-16 Argon-55.2	12T	1,1	0,066	1,4	1,5	18	16	0,4

		HFC/HVC		HFC/HVC							
TG	LowE	8H LowE-12 Krypton-4HS-12 Krypton-55.2HS LowE	16K	0,5	0,080	0,86/0,87	0,96/0,99	70	51	1,2	
	Sun1	8H Sun1-12 Krypton-4HS-12 Krypton-55.2HS LowE	17K	0,5	0,080	0,86/0,87	0,96/0,99	45	25	0,6	
	LowE	8H LowE-12 Argon-4HS-12 Argon-55.2HS LowE	16T	0,7	0,080	1,0	1,1	70	50	1,2	
	Sun1	8H Sun1-12 Argon-4HS-12 Argon-55.2HS LowE	17T	0,7	0,080	1,0	1,1	44	25	0,6	
	Sun2	8H Sun2-12 Argon-4HS-12 Argon-55.2HS LowE	18T	0,7	0,080	1,0	1,1	16	14	0,3	

TG/ DG	Coating	Pane specification	IGU	Colour rendering index R _a	Direct air-born sound reduction IGU R _w (C, C _{tr})	Acoustic performance window ¹⁾²⁾ R _w (C, C _{tr})	Rain noise Lia	Total solar energy direct absorption a	Resistance to pendulum body impact Class	Resistance to burglary Class								
											IGU	R _a	R _w (C, C _{tr})	R _w (C, C _{tr})	Lia	a	Class	Class
											Construction (outside - inside)	code	%	dB	dB	dB	%	Outside/Inside
DG	LowE	8H-20 Argon-33.2 LowE	10	96,4	37 (-2;-5)	36 (-1;-5)	49	27	1C1/1B1	P2A								
	Sun1	8H Sun1-20 Argon-33.2	11	91,2	37 (-2;-5)	36 (-1;-5)	49	31	1C1/1B1	P2A								
	Sun2	8H Sun2-20 Argon-33.2	12	90,7	37 (-2;-5)	36 (-1;-5)	49	61	1C1/1B1	P2A								
TG	LowE	8H LowE-12 Argon-8HS-12 Argon-33.2F LowE	16	95,2	39 (-3;-6)	37 (-1;-6)	48	32	1C1/NPD/1B1	P2A								
	Sun1	8H Sun1-12 Argon-8HS-12 Argon-33.2F LowE	17	89,5	39 (-3;-6)	37 (-1;-6)	48	44	1C1/NPD/1B1	P2A								
	Sun2	8H Sun2-12 Argon-8HS-12 Argon-33.2F LowE	18	90,1	39 (-3;-6)	37 (-1;-6)	48	63	1C1/NPD/1B1	P2A								
DG	LowE	8H-16 Argon-55.2 LowE	10T	95,4	41(-1;-4)	38 (-1;-4)	49	31	1C1/1B1	P2A								
	Sun1	8H Sun1-16 Argon-55.2	11T	90,1	41(-1;-4)	38 (-1;-4)	49	35	1C1/1B1	P2A								
	Sun2	8H Sun2-16 Argon-55.2	12T	89,9	41(-1;-4)	38 (-1;-4)	49	61	1C1/1B1	P2A								

TG	LowE	8H LowE-12 Krypton-4HS-12 Krypton-55.2HS LowE	16K	95,9	42 (-2;-6)	38 (-1;-4)	48	31	1C1/NPD/1B1	P2A
	Sun1	8H Sun1-12 Krypton-4HS-12 Krypton-55.2HS LowE	17K	90,2	42 (-2;-6)	38 (-1;-4)	48	44	1C1/NPD/1B1	P2A
	LowE	8H LowE-12 Argon-4HS-12 Argon-55.2HS LowE	16T	95,9	42 (-2;-6)	38 (-1;-4)	48	31	1C1/NPD/1B1	P2A
	Sun1	8H Sun1-12 Argon-4HS-12 Argon-55.2HS LowE	17T	90,2	42 (-2;-6)	38 (-1;-4)	48	44	1C1/NPD/1B1	P2A
	Sun2	8H Sun2-12 Argon-4HS-12 Argon-55.2HS LowE	18T	90,8	42 (-2;-6)	38 (-1;-4)	48	63	1C1/NPD/1B1	P2A

Notes:

¹⁾ For product sizes A ≤/ = 2,7 m². For product sizes of 2,7m² < A < 3,6 m² the sound insulation values shall be deducted by 1 dB

²⁾ The R_w-value indicates the number of decibels by which a window will reduce apparent noise.

R_w+C is an adjustment factor to account for high frequency noise sources e.g. living activities (talking, music, radio, TV), railway traffic at medium to high speed, road traffic exceeding 80 km/h, or a jet aircraft.

R_w+C_{tr} is an adjustment factor to account for low frequency noise sources e.g. urban road traffic or railway traffic at low speeds.

Glazing Unit



Fire resistant glazing units

Double	Coating	IGU	IGU	U _g	ψ	τ _v	g	Ra
Double glazing	LowE	6H LowE-9Krypton - 5H - Int.6 - 44.2F	10U	1.0	0.083	76	60	96
	Sun1	6H Sun1-9Krypton - 5H - Int.6 - 44.2F	11U	1.0	0.083	64	40	92
	Sun2	6H Sun2-9Krypton - 5H - Int.6 - 44.2F	12U	1.0	0.083	57	32	90

Pane coatings	
LowE	Low emissivity coating
Sun1	Light sun protection coating
Sun2	Advanced sun protection coating

Description	Explanation	Characteristic bending strength
H	Toughened	120,0 N/mm ²
HS	Heat strengthened	70,0 N/mm ²
F	Float	45,0 N/mm ²
Int	Inter layer (Fire Gel)	-

Example of glazing unit construction

From outside - inside	
IGU 16	8H LowE-12 Argon-8HS-12Argon-33.2F LowE
8H	8 mm pane with toughened glass
LowE	Low energy coating
12 Argon	12 mm argon filled cavity
8HS	8 mm pane with heat strengthened glass
12 Argon	12 mm argon filled cavity
33.2F	Laminated float glass pane, 3 + 3 mm, 2 x 0,38 mm PVB
LowE	Low energy coating

Notes:

¹⁾ For product sizes A ≤/ = 2,7 m². For product sizes of 2,7m² < A < 3,6 m² the sound insulation values shall be deducted by 1 dB

²⁾ The R_w-value indicates the number of decibels by which a window will reduce apparent noise.

R_w+C is an adjustment factor to account for high frequency noise sources e.g. living activities (talking, music, radio, TV), railway traffic at medium to high speed, road traffic exceeding 80 km/h, or a jet aircraft.

R_w+C_{tr} is an adjustment factor to account for low frequency noise sources e.g. urban road traffic or railway traffic at low speeds.

General notes:

- It is up to the customer to verify the chosen glazing unit against the project specific conditions following the national requirement.
- Production height for calculation of climatic load is from 0 to 300 meter above sea level.
- Modules higher than 2400 mm will be delivered with a T-pane

Product name	VELUX INTEGRA®	Product code	10000000000000000000
Product description	Chain actuator	Product code	10000000000000000000
Product type	Chain actuator	Product code	10000000000000000000
Product category	Chain actuator	Product code	10000000000000000000
Product group	Chain actuator	Product code	10000000000000000000
Product sub-group	Chain actuator	Product code	10000000000000000000
Product version	Chain actuator	Product code	10000000000000000000
Product status	Chain actuator	Product code	10000000000000000000
Product availability	Chain actuator	Product code	10000000000000000000
Product lead time	Chain actuator	Product code	10000000000000000000
Product weight	Chain actuator	Product code	10000000000000000000
Product dimensions	Chain actuator	Product code	10000000000000000000
Product image	Chain actuator	Product code	10000000000000000000

Vapour Barrier Connection Strip



Membrane	Polyethylene (PE-LD) 150 µm
Gasket	Welded rubber EPDM seal gasket
Height	200 mm
Length	10.000 mm (10 m)

Chain Actuator



VELUX INTEGRA®	
Material	Anodised aluminium housing with zinc cromate passivated steel chain
Weight	Max 5.5 kg
Control system	VELUX INTEGRA®
Supply cable*	0.3 m silicone cable, 4 cord, 0,75 mm ² (white, brown, black, red)
Chain stroke	Up to 410 mm (depending on module size)
Opening speed	4 mm/s
Sound level	TBD
Holding force (tractive)	5000 N (burglary strength) min.
Pressure force	1000 Newton
Tractive force	500 Newton
Operation conditions	-15°C - +76°C, max. 90% relative humidity (not condensing)
Nominal voltage**	24 V DC
Power consumption	Max. 200 W (peak)
Service	It is recommended to carry out a function test of the actuator at least once a year and to make sure that the skylight opens correctly
CE marking	The product is tested with the VELUX KLC 400 control units and complies with the EMC directive's requirements for use in residential, commercial and light commercial buildings
Reservation	The VELUX Group reserve the right to technical changes

* The supply cable is only for connection with VELUX control unit KLC 400.
 ** Supplied by VELUX control unit KLC 400

Chain Actuator



Open system	
Material	Anodised aluminium housing with zinc cromate passivated steel chain
Weight	Max 5.5 kg
Control system	MotorLink™ or ±24 V DC*
Supply cable**	5 m grey silicone cable, 3 cord, 0.75 mm ² (white brown green**)
Chain stroke	Up to 700 mm (depending on module size)
Opening speed	HVC ----CB (comfort) 7 mm/s HVC ----AB (smoke and comfort) 13 mm/s
Sound level	32 dB (min speed)***
Holding force (tractive)	5000 N (burglary strength) min
Pressure force	1000 Newton* (smoke ventilation: 1300 Newton)
Tractive force	300-1000 Newton*
IP rating	IPX4
Operation conditions	-15°C - +76°C, max. 90% relative humidity (not condensing)
Nominal voltage	24 V DC (max 10% ripple)
Voltage	19-32 V DC
Max Voltage	32 V DC
Switch-on-duration	ED max 20% (2 minutes per 10 minutes)
Current consumption	HVC ----CB (comfort) max. 2A HVC ----AB (smoke and comfort) max 5,5A
Service	It is recommended to carry out a function test of the actuator at least once a year and to make sure that the skylight opens correctly
CE marking	The product is tested with the original WindowMaster control units and complies with the EMC directive's requirements for use in residential, commercial and light commercial buildings
Reservation	The VELUX Group reserve the right to technical changes

*At standard ± 24 V DC connection maximum distances from venting skylight to power supply in accordance to calculation:

$$\text{Max cable length} = \frac{\text{(admissible voltage drop (UL) x conductivity of copper (56) x cable cross section (a))}}{\text{(total max.actuator current (I)in amps x 2)}}$$

At MotorLink™ (3 cord) connection maximum distances from roller blind to motor controller (power supply) is 50 m.

**Green = communication wire

*** The sound level can vary depending on the opening speed and building conditions

Maximum drive time for comfort ventilation (HVC ---AB)		
Module length	Chain length [mm]	Drive time [sec]
800	353	27
1000	410	32
1200	410	32
1400	410	32
1600	410	32
1800	410	32
2000	410	32
2200	410	32
2400	410	32
2600	410	32
2800	410	32

When using a smoke venting skylight module (HVC AB) for comfort ventilation also, the chain stroke must be limited by the drive time in order to prolong lifetime expectancy of the module. The drive time must be limited according to this table.

Product name	VELUX INTEGRA®	Product code	00000000000000000000
Product description	VELUX INTEGRA® control system	Product code	00000000000000000000
Product code	00000000000000000000	Product code	00000000000000000000
Product code	00000000000000000000	Product code	00000000000000000000
Product code	00000000000000000000	Product code	00000000000000000000
Product code	00000000000000000000	Product code	00000000000000000000
Product code	00000000000000000000	Product code	00000000000000000000
Product code	00000000000000000000	Product code	00000000000000000000
Product code	00000000000000000000	Product code	00000000000000000000
Product code	00000000000000000000	Product code	00000000000000000000

Control System



KLC 400	
Material and colour	Black fire resistant polycarbonate
Size and weight	Product including packaging: 587 mm x 80 mm x 166 mm (W x H x D) 2.0 kg Control unit: 380 mm x 36 mm x 87 mm (W x H x D) 1.5 kg
Installation	24 V DC SELV class III construction output. The control unit is for use in small/medium installations with VELUX modular skylights. The control unit is installed under the front flashing of VELUX modular skylights and functions at temperatures between -15°C and +50°C. ta = 40°C It is equipped with a 10 m 2-core cable (2 x 1,5mm ² H05VV-F) and plug for connection to the mains supply. Radio frequency range: 300 m range open field. Depending on the building construction, the indoor range is approximately 30 m.
IP rating	IPX4
Power consumption	Primary side: 230/240 V AC - 50 Hz / 200W Secondary side: 24 V DC - 5 A class III construction output.
Connection	The control unit is only to be used with VELUX modular skylights and VELUX roller blinds RMM. The control unit can supply power to one venting skylight module and/or up to four roller blinds RMM. The connection wires are prefitted with wire-to-wire connectors. The connection wire to the chain actuator may not be extended.
Compatibility	KLC 400 is based on radio frequency (RF) technology and signals are transmitted in the 868 MHz range. It is compatible with products with the io-homecontrol® logo and can be used with VELUX modular skylights chain actuator and roller blinds RMM. VELUX electrical products connected to KLC 400 can be operated by io-homecontrol® compatible activation controls.
CE marking	CE marked to indicate that it is in accordance with the following EU directives: CPR, LVD, MD, RoHS, WEEE, R&TTE, Packaging waste directive and EMC for household, trade and light industry. Combinations of VELUX electrical products meet the requirements of above-mentioned directives.
Note	VELUX reserve the right to make technical changes.



KLR 200	
Material and colour	ABS, white (NCS S 1000-N), black (RAL 9005) and metallic grey
Size and weight	Product including packaging: 235 x 153 x 48 mm (W x H x D), 250 g Control pad: 95 x 95 x 23 mm (W x H x D), 180 g
Use	For indoor use, maximum ambient temperature 50 °C Radio frequency range: 200 m range open field. Depending on the building construction, the indoor range is approximately 20 m Maximum number of products is 200*
Power consumption	3 x Alkaline AA (1.5 V) batteries Expected battery lifetime: Approximately 1 year
Compatibility	Based on radio frequency (RF) technology, transmitted in 868 MHz range. Compatible with products with the io-homecontrol® logo. Can be used with all VELUX INTEGRA® and VELUX INTEGRA® Solar products.
CE marking	This product has been CE-marked to indicate that it is in accordance with relevant EU directives. The product has been tested with other genuine VELUX INTEGRA® products and together with these it meets the requirements of the LVD and EMC directive for household, trade and light industry.
Note	This product has been designed for use with genuine VELUX products. The connection to other products may cause damage or malfunction. VELUX Group reserve the right to make technical changes.
CE marking	CE marked to indicate that it is in accordance with the following EU directives: CPR, LVD, MD, RoHS, WEEE, R&TTE, Packaging waste directive and EMC for household, trade and light industry. Combinations of VELUX electrical products meet the requirements of above-mentioned directives.
Note	VELUX reserve the right to make technical changes.

* Maximum recommended number of products is 100 and for daily use it is 50.

Roller Blind



VELUX INTEGRA®		
Materials (visible parts)	Fabric	Polyester
	Wire	Stainless steel
	Control bar	Anodized aluminium
	Top pulley wheels	Stainless steel
Colours (cloth)	Grey, black and white	
Weight	Max 3.4 kg	
Installation	Please see installation instructions	
Compatibility	All VELUX modular skylights with VELUX INTEGRA® control system	
Control system	VELUX INTEGRA®	
Supply cable	0.2 m silicone cable, 2 cord, 0.75 mm ² (white, brown)	
Running speed	70 mm/sec	
Sound level	TBD	
Operating conditions	-15°C - +75°C, max. 90% relative humidity (not condensing)	
Nominal voltage	24 V DC. Can only be supplied by KLC 400.	
Power consumption	0,4 A	
Service	It is recommended to carry out a function test of the roller blind at least once a year and to make sure that the roller blind runs correctly	
CE marking	The product is tested with the VELUX KLC 400 control units and complies with the EMC directive's requirements for use in residential, commercial and light commercial buildings	
Reservation	The VELUX Group reserve the right to technical changes	

Product name	VELUX	Model	1000
Product code	1000	Product description	VELUX
Product category	1000	Product type	VELUX
Product version	1000	Product status	VELUX
Product date	1000	Product location	VELUX
Product manufacturer	1000	Product distributor	VELUX
Product supplier	1000	Product retailer	VELUX
Product installer	1000	Product maintainer	VELUX
Product user	1000	Product owner	VELUX

Roller Blind



Open system		
Materials (visible parts)	Fabric	Polyester
	Wire	Stainless steel
	Control bar	Anodized aluminium
	Top pulley wheels	Stainless steel
Colours (cloth)	Grey, black and white	
Weight	Max 3.4 kg	
Installation	See installation instruction	
Compability	All VELUX modular skylights with open system control	
Control system	MotorLink™ or ±24 V DC	
Supply cable*	0.5 m grey silicone cable, 3 cord, 0.75 mm ² (white, brown, green**)	
Running speed	30-70 mm/sec	
Sound level	TBD	
IP rating	IPX0	
Operating conditions	-15°C - +75°C, max 90 % relative humidity (not condensing)	
Nominal voltage	24 V DC (max 10 % ripple)	
Voltage	19-32 V DC	
Max. voltage	32 V DC	
Switch-on-duration	ED max 20 % (2 minutes per 10 minutes)	
Current consumption	Max 1A	
Service	It is recommended to carry out a function test of the roller blind at least once a year and to make sure that the roller blind runs correctly	
CE marking	The product is tested with the original WindowMaster control units and complies with the EMC directive's requirements for use in residential, commercial and light commercial buildings	
Reservation	The VELUX Group reserve the right to technical changes	

* At standard ± 24 V DC connection maximum distances from roller blind to power supply in accordance to calculation:

$$\text{Max.cable length} = \frac{\text{admissible voltage drop (UL)} \times \text{conductivity of copper (56)} \times \text{cable cross section (a)}}{\text{total max.actuator current (I)} \text{ in amps} \times 2}$$

At MotorLink™ (3 cord) connection maximum distances from roller blind to motor controller (power supply) is 50 m.

**Green = communication wire for MotorLink™

Roller Blind



Roller blind cloth properties				
Colour	Normal cloth			Fire resistant
	Grey (4083)	White (4084)	Black (4085)	White (4094)
Radiation properties without glazing unit				
Light transmittance				
Light reflectance				
Light absorption				
Reaction to Fire				
Norm				Class
EN 13501-1		-		B, s1-d0
DIN 4202-1		-		B1
NF P 92 503 -507		-		M1

Roller blind effects on double-glazing unit									
Pane variant	10			11			12		
	g-value	T-value	Fc-value	g-value	T-value	Fc-value	g-value	T-value	Fc-value
Without RMM									
With RMM									
Grey (4083)									
White (4084)									
Black (4085)									
White, fire resistant (4094)									

Roller blind effects on double-glazing unit									
Pane variant	10T			11T			12T		
	g-value	T-value	Fc-value	g-value	T-value	Fc-value	g-value	T-value	Fc-value
Without RMM									
With RMM									
Grey (4083)									
White (4084)									
Black (4085)									
White, fire resistant (4094)									

Product name	Roller blind effects on triple-glazing unit	Product code	10000000000000000000
Product description	Roller blind effects on triple-glazing unit	Product code	10000000000000000000
Product code	10000000000000000000	Product code	10000000000000000000
Product code	10000000000000000000	Product code	10000000000000000000
Product code	10000000000000000000	Product code	10000000000000000000
Product code	10000000000000000000	Product code	10000000000000000000
Product code	10000000000000000000	Product code	10000000000000000000
Product code	10000000000000000000	Product code	10000000000000000000
Product code	10000000000000000000	Product code	10000000000000000000
Product code	10000000000000000000	Product code	10000000000000000000

Roller Blind



Roller blind effects on triple-glazing unit									
Pane variant	16			17			18		
	g-value	T-value	Fc-value	g-value	T-value	Fc-value	g-value	T-value	Fc-value
Without RMM									
With RMM									
Grey (4083)									
White (4084)									
Black (4085)									
White, fire resistant (4094)									

Roller blind effects on triple-glazing unit									
Pane variant	16T			17T			18T		
	g-value	T-value	Fc-value	g-value	T-value	Fc-value	g-value	T-value	Fc-value
Without RMM									
With RMM									
Grey (4083)									
White (4084)									
Black (4085)									
White, fire resistant (4094)									

g-value:

"The total transmitted fraction of the incident solar radiation consisting of direct transmitted solar radiation and the part of the absorbed solar radiation transferred by convection and thermal radiation to the internal environment." (EN 13363-2)

"The fraction of the incident solar radiation that is totally transmitted by the glass." (EN 410)

The g-value (total solar energy transmittance) is a measure of how much solar energy that is transmitted through the construction in the cooling period.

The g-value is defined as the ratio between the solar energy transmitted through the glazing and the incident solar factor on the glazing.

T-value:

"The transmitted fraction of the incident solar radiation in the visible part of the solar spectrum, see EN 410" (EN 13363-2)

"The fraction of incident light that is transmitted by the glass." (EN 410)

Fc-value:

"The shading factor, F_c-value, is the ratio of the solar factor of the combined glazing and solar protection device, g_{tot}, to that of the glazing alone, g. F_c=g_{tot}/g

Note: in some countries, F_c is known as z." (EN 14501)

Beam for Ridgelight at 5°



Material	Steel
Material thickness	3 mm
Construction	Hollow beam
Surface	Primed RAL 9003
Foam gasket on beam	15 mm

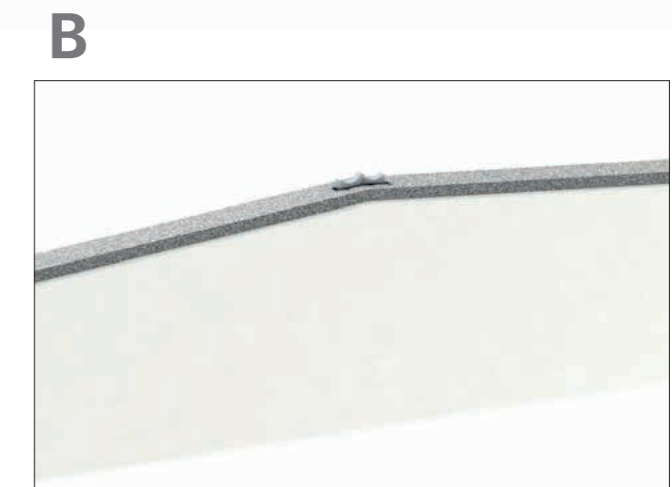
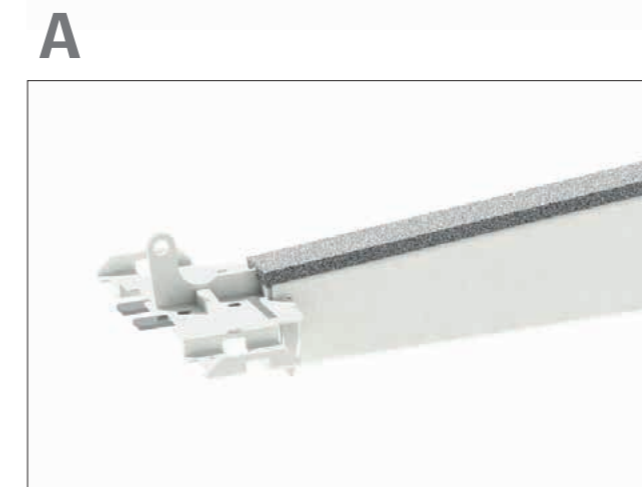
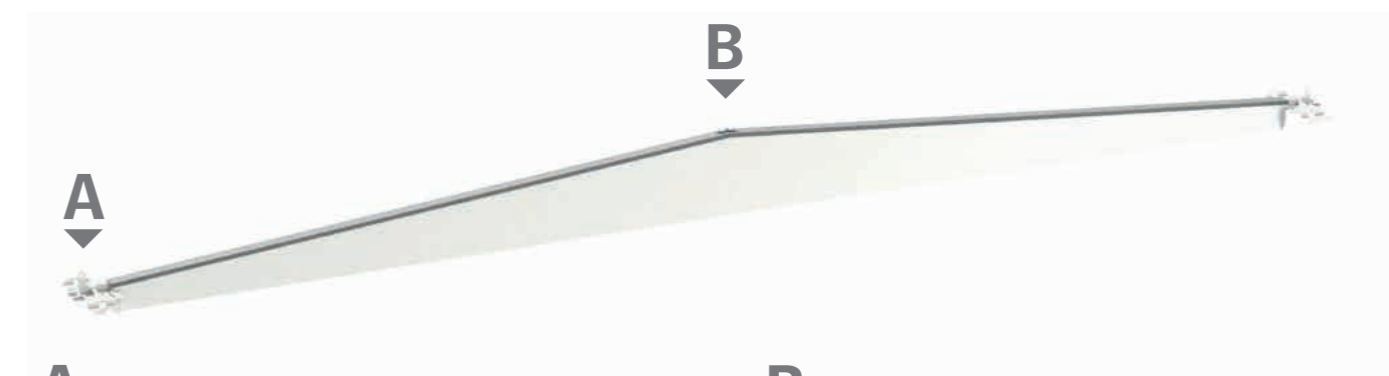

Product name	VELUX modular skylights	Product code	1000000000
Product type	Skylight	Material	Aluminum
Product description	VELUX modular skylights	Color	Black
Product dimensions	1000x1000x100	Weight	10kg
Product weight	10kg	Volume	0.01m³
Product volume	0.01m³	Surface area	10m²
Product surface area	10m²	Installation type	Roof
Product installation type	Roof	Installation instructions	See manual
Product installation instructions	See manual	Product warranty	5 years
Product warranty	5 years	Product availability	In stock
Product availability	In stock	Product status	Active
Product status	Active	Product last updated	2023-10-27
Product last updated	2023-10-27	Product version	1.0
Product version	1.0	Product category	Skylights
Product category	Skylights	Product sub-category	Modular skylights
Product sub-category	Modular skylights	Product manufacturer	VELUX
Product manufacturer	VELUX	Product country of origin	Denmark
Product country of origin	Denmark	Product compliance	EN ISO 11925-2, EN 13823
Product compliance	EN ISO 11925-2, EN 13823	Product certification	CE
Product certification	CE	Product safety	See manual
Product safety	See manual	Product safety instructions	See manual
Product safety instructions	See manual	Product safety warnings	See manual
Product safety warnings	See manual	Product safety symbols	See manual
Product safety symbols	See manual	Product safety icons	See manual
Product safety icons	See manual	Product safety labels	See manual
Product safety labels	See manual	Product safety notices	See manual
Product safety notices	See manual	Product safety notices	See manual

Reaction to Fire

Test method: EN ISO 11925-2, EN 13823

Reaction to fire classes for building products (excl. floorings)							
Main class	Smoke class	Burning droplets class	Requirements according to			FIGRA	
			Non comb	SBI	Small flame	W/s	
A1	-	-	x	-	-	-	Non combustible
A2	s1 - s3	d0 - d2	x	x	-	≤ 120	
B	s1 - s3	d0 - d2	-	x	x	≤ 120	
C	s1 - s3	d0 - d2	-	x	x	≤ 250	
D	s1 - s3	d0 - d2	-	x	x	≤ 750	
E	-	- or d2	-	-	x	-	
F	-	-	-	-	-	-	No performance determined

¹⁾ The test is a corner basket test, which show how much the product contribute to the development of fire.

Internal fire spread and smoke contribution.

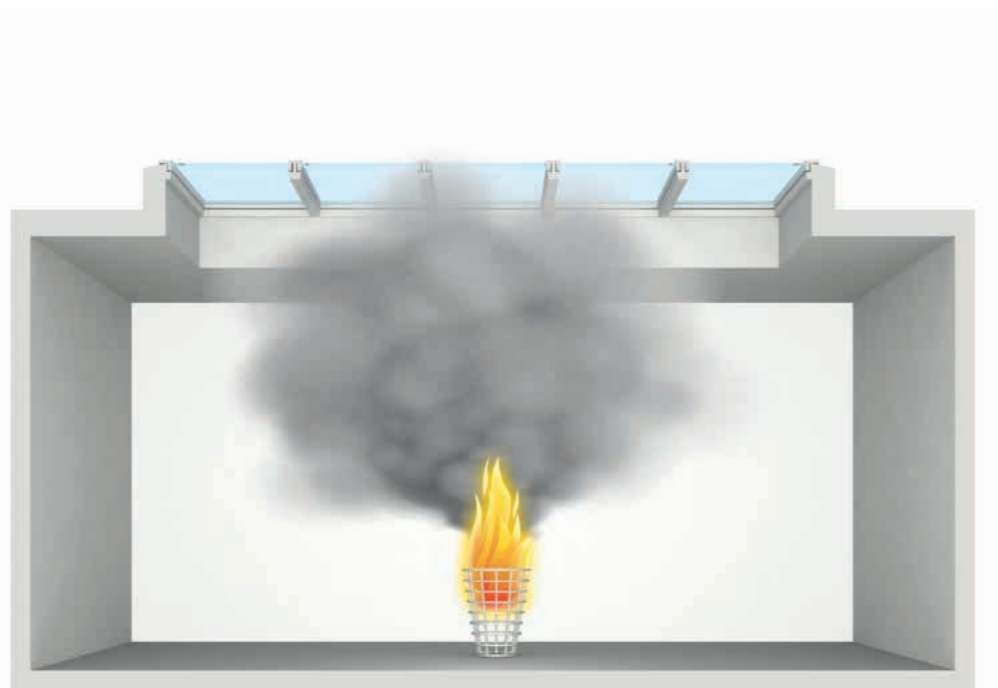

Reaction to Fire

Classification: EN 13501-1

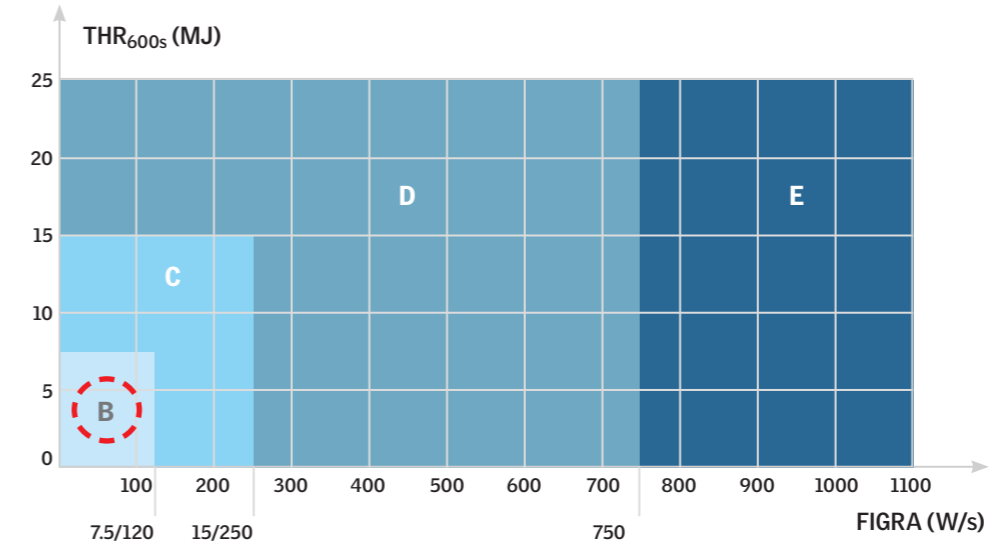

Smoke subclass

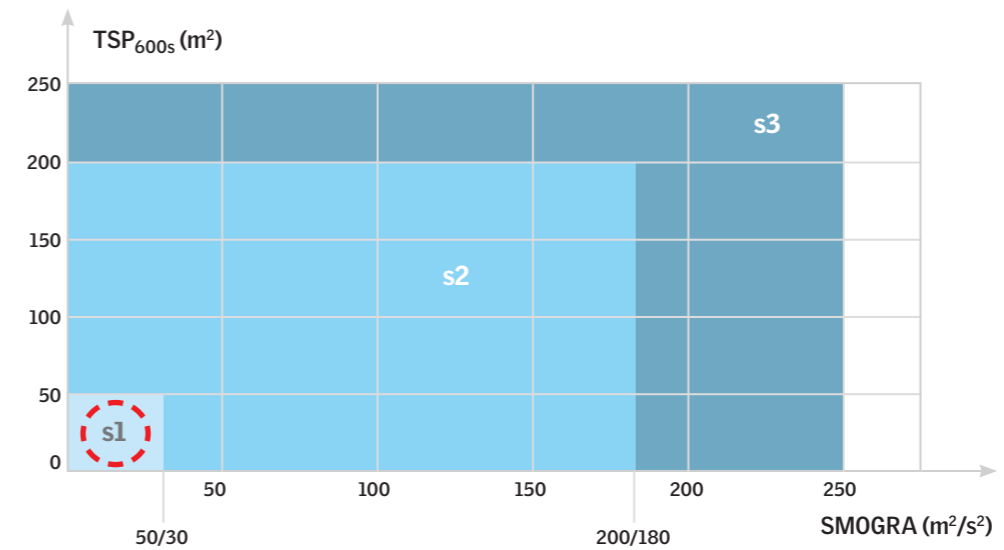

CLASSIFICATION

- A1, A2, B: Non-combustible and not very combustible product. Over 20 minutes to flashover.
- C: Moderate combustible products. Between 10 and 20 minutes to flashover.
- D: Moderate combustible products. Between 2 and 10 minutes to flashover.
- E: Moderate combustible products.
- F: Highly combustible products (or products whose reaction to fire has not been assessed).

SUB-CLASS

- s1: Low smoke production.
- s2: Medium smoke production.
- s3: High smoke production.

FLAMING DROPLETS SUB-CLASSIFICATION

- d0: No flaming droplets.
- d1: Flaming droplets that persist for less than 10 s.
- d2: Flaming droplets.

VELUX modular skylights: Clas B, s1-d0 or d2

B: Very low combustibility
(A: Incumbustible eg steel and concrete)

s1: Lowest smoke volume
d0: No droplets in T pane variants
d2: Droplets in standard pane variant

Product	VELUX modular skylights	Accessories	Accessories
Model	VELUX modular skylights	Accessories	Accessories
Material	Aluminum	Accessories	Accessories
Color	Black, Silver	Accessories	Accessories
Weight	10 kg	Accessories	Accessories
Dimensions	1000 x 1000 mm	Accessories	Accessories
Installation	Standard	Accessories	Accessories
Warranty	10 years	Accessories	Accessories
Manufacturer	VELUX	Accessories	Accessories

Watertightness

Test method: EN 1027

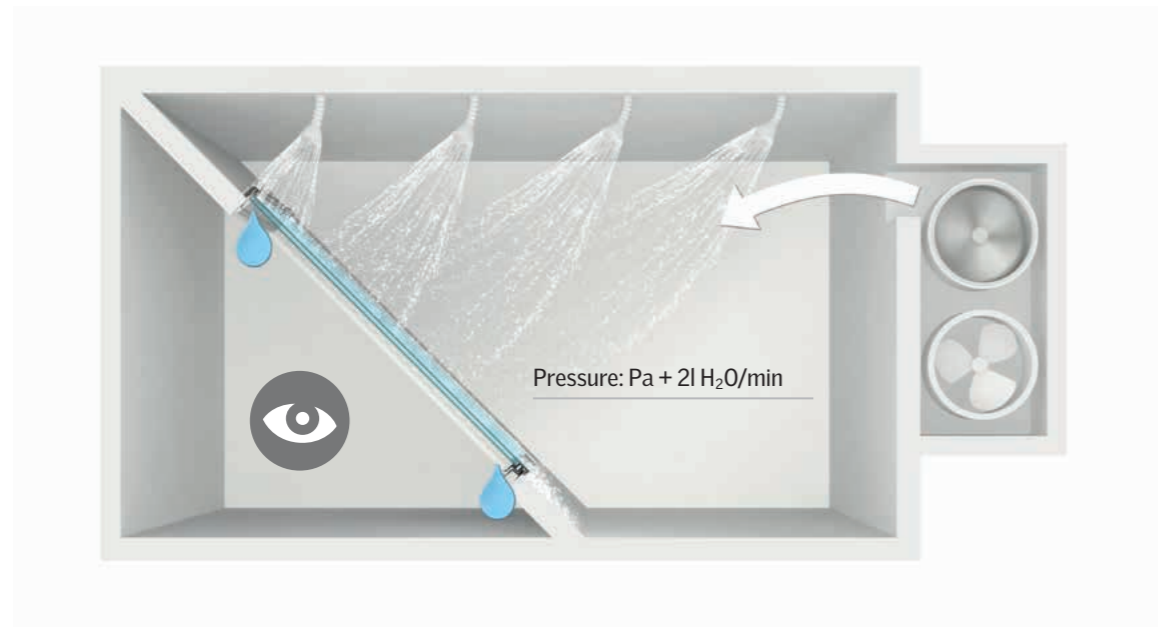
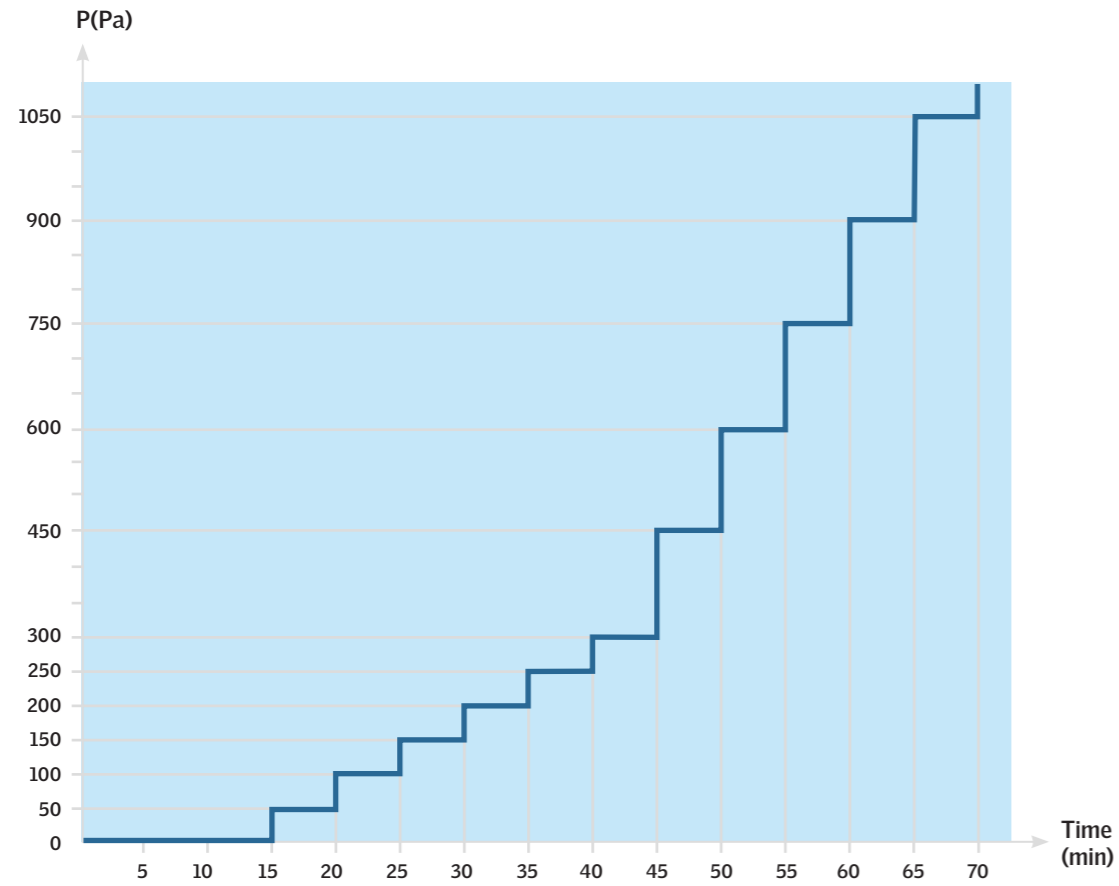

Watertightness

Classification: EN 12208

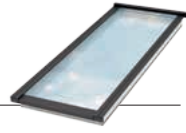

Water tightness		
Classification	Pressure (Pa)	Wind (Km/h)
1 A	0	0
2 A	50	32
3 A	100	45
4 A	150	55*
5 A	200	63
6 A	250	71
7 A	300	78
8 A	450	95
9 A	600	110
E 750	750	123**
E 900	900	134

* Equal to depression
 ** Equal to tropical storm

VELUX modular skylights: E900
 No water penetration up to 900 Pa.
 900 Pa equals 134 Km/h.

Property	Value	Unit	Reference
Weight	1.2	kg/m²	EN 12207
Sound insulation	20	dB	EN 12207
U-value	0.8	W/m²K	EN 12207
Water resistance	0.5	l/m²h	EN 12207
Wind resistance	1000	Pa	EN 12207
Impact resistance	1000	J/m²	EN 12207
Fire resistance	30	min	EN 12207
Light transmission	80	%	EN 12207
Glare reduction	10	%	EN 12207
UV protection	90	%	EN 12207
Temperature range	-40 to +70	°C	EN 12207
Wind class	4		EN 12207
Water class	4		EN 12207
Sound class	2		EN 12207
Fire class	1		EN 12207
Impact class	1		EN 12207
Light class	1		EN 12207
Glare class	1		EN 12207
UV class	1		EN 12207
Temperature class	1		EN 12207

Air Permeability

Test method: EN 1026

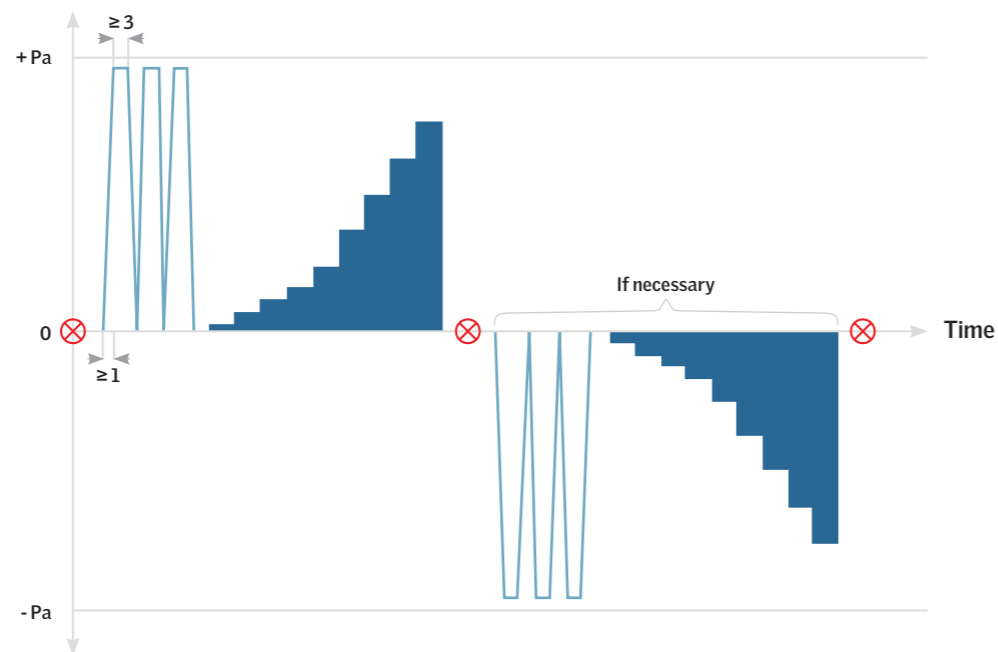

⊗ Opening and closing

Test Pressure

- 150 Pa - Class 1
- 300 Pa - Class 2
- 600 Pa - Class 3, 4

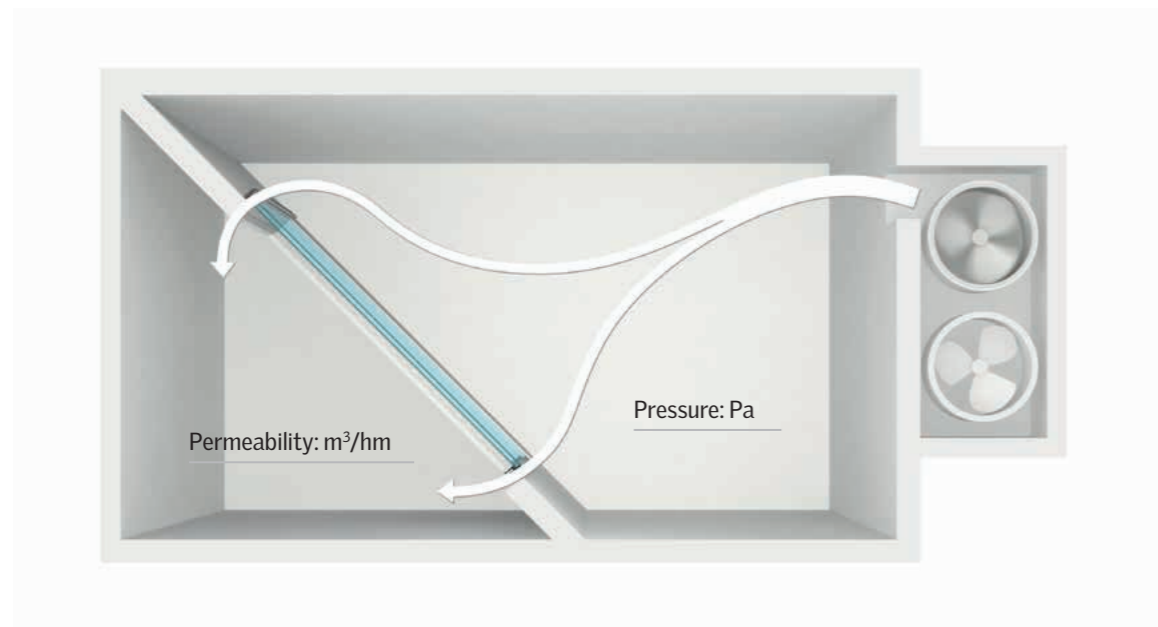

Air Permeability

Classification: EN 12207

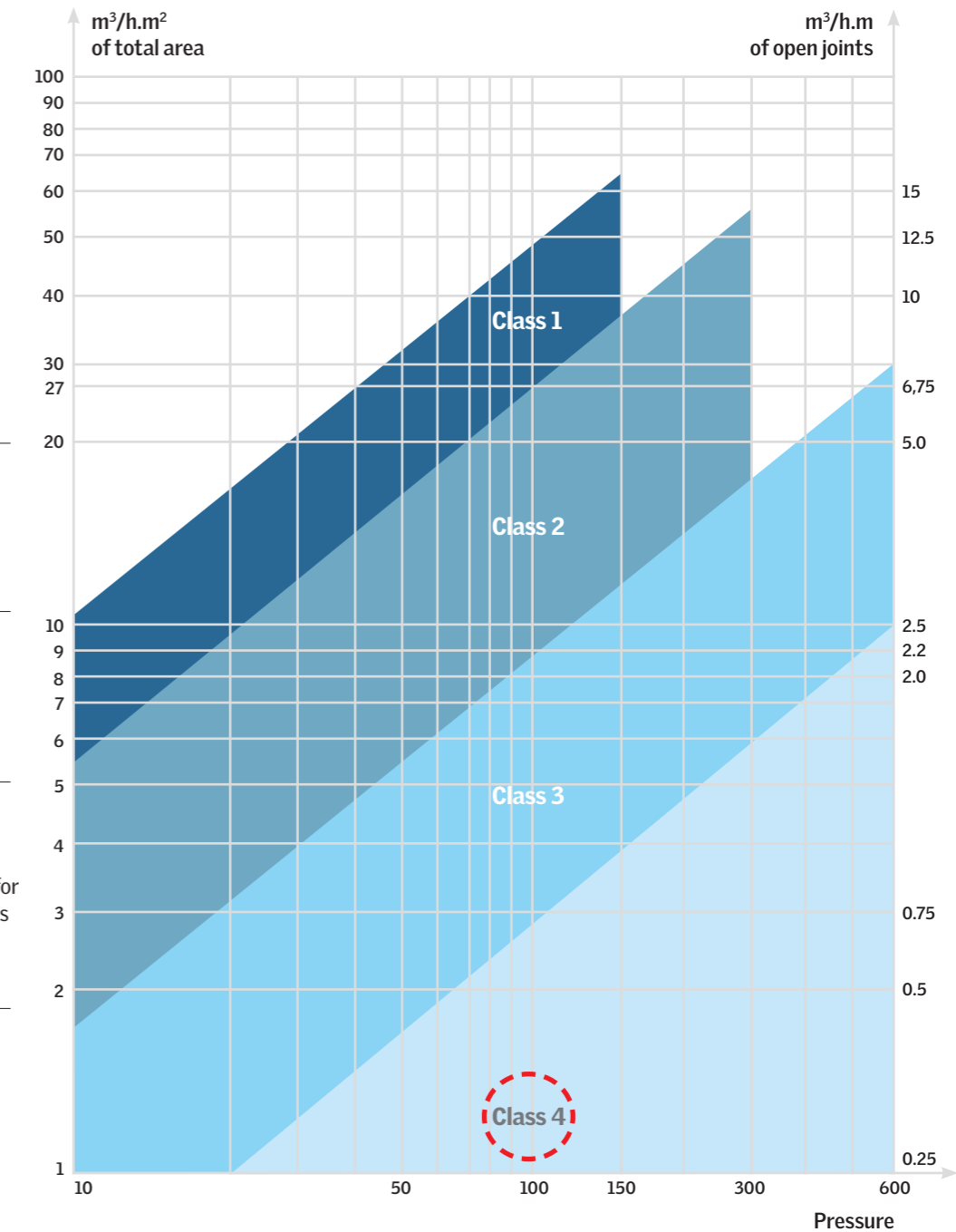

Class 1

- Poor air permeability
- Draught
- Major heat loss

Class 2

- Modest air permeability
- Draught in wind
- Large Heat loss

Class 3

- Good air permeability
- Low heat loss
- Minimum requirement in most EU member states for heated inhabited buildings

Class 4

- Highest air permeability
- Draught < 2.6 m³/hm through joint
- Tight in most conditions
- Small draught at peak pressure

⊗ VELUX moduler skylights: Class 4

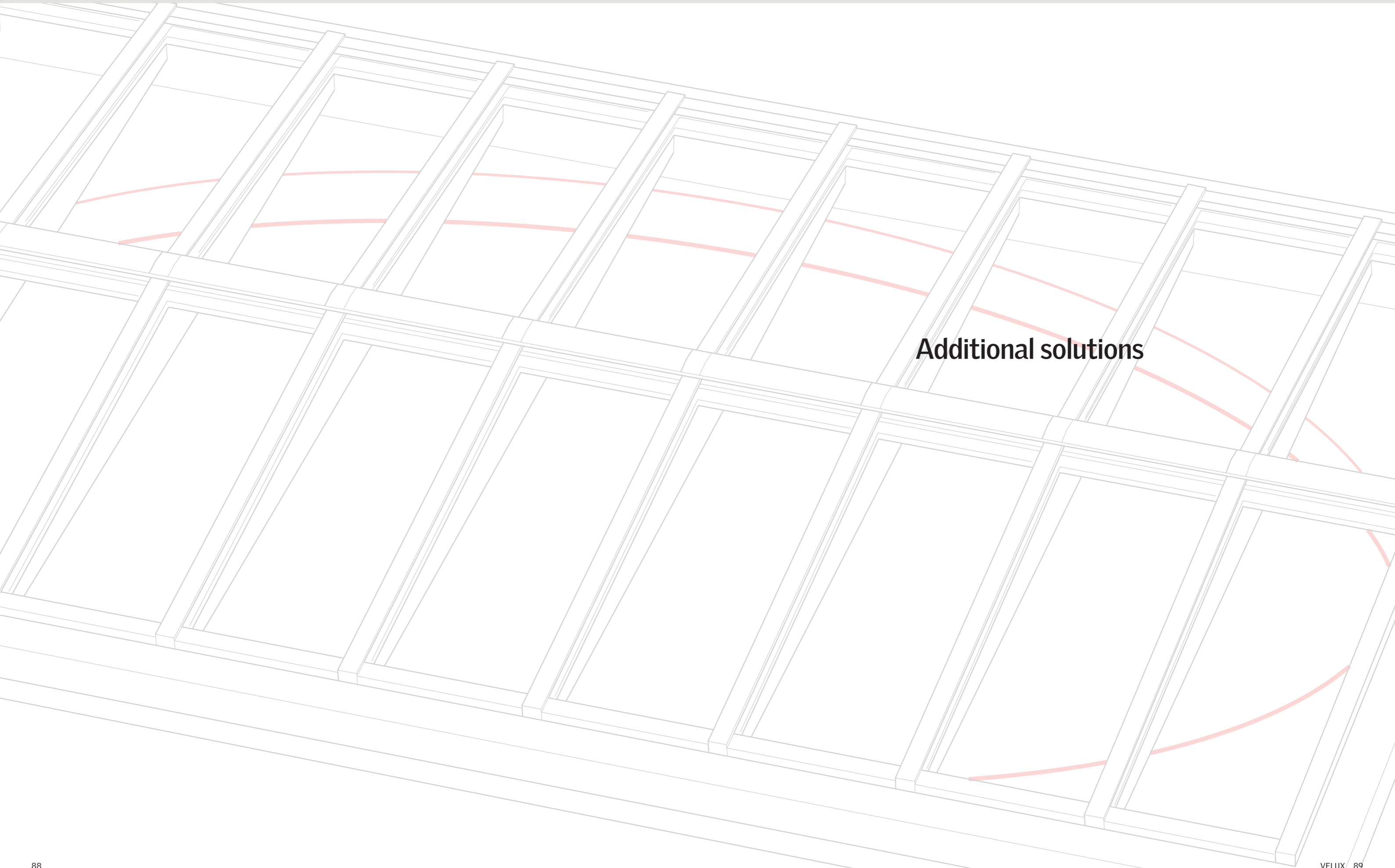

Additional solutions

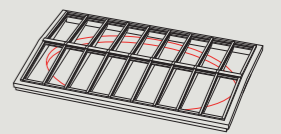

Shaped Solution with Adaption of Lining

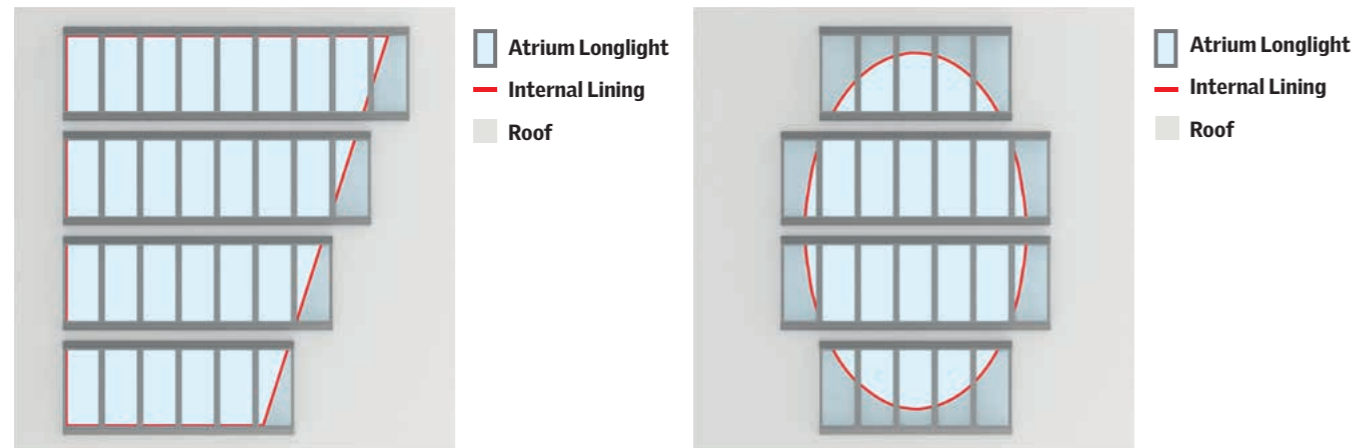

Feature	Advantage	Benefit
By adapting the internal lining it is possible to build a shaped skylight with standard skylight modules.	By using standard skylight modules on non-square roof designs, the architects will not have to compromise the wishes for the interior design. The solution can be combined with venting skylights and internal roller blinds.	Using standard products with standard installation principles gives high security in the design and building process. Installing venting skylights and roller blinds gives a better indoor climate.

Asymmetric Ridgelight

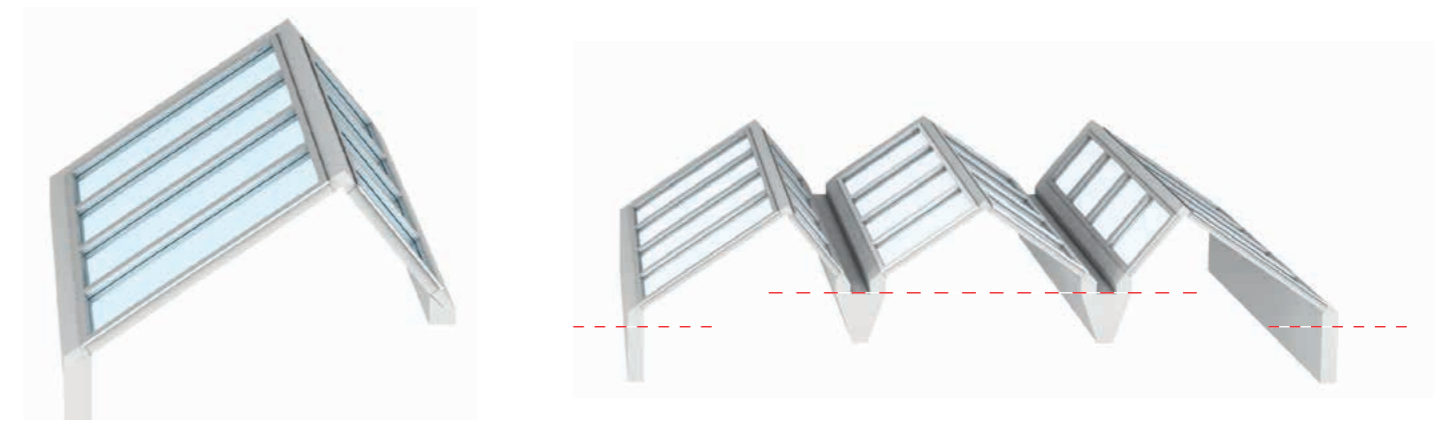

Feature	Advantage	Benefit
By constructing an asymmetric ridgeline it is possible to combine modules of different length in an installation.	The solution allows for installation between two roofs of different heights, or of modules in different slopes. By combining panes with different characteristics on each side of the ridgeline, it is possible to maximize daylight and minimize heat gain.	The asymmetric ridgeline offers more flexibility in installation between buildings or sections of buildings.

Shaped Solution with Oval Lining

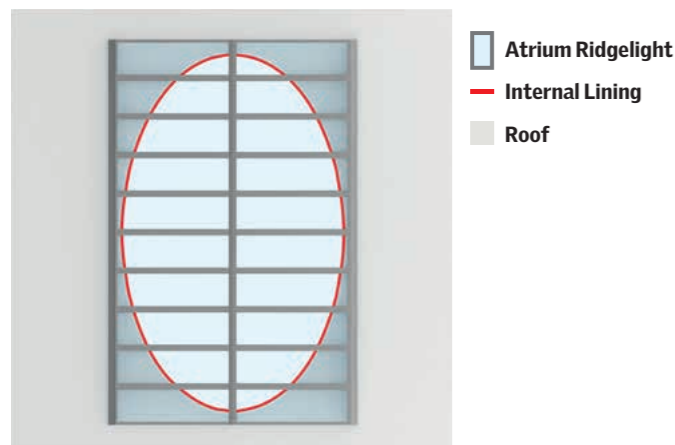

Feature	Advantage	Benefit
By adapting the internal lining it is possible to build a shaped skylight with standard skylight modules.	By using standard skylight modules on non-square roof designs, the architects will not have to compromise the wishes for the interior design.	Using standard products with standard installation principles gives high security in the design and building process. The solution can be combined with internal roller blinds.

Atrium of Combined Solutions

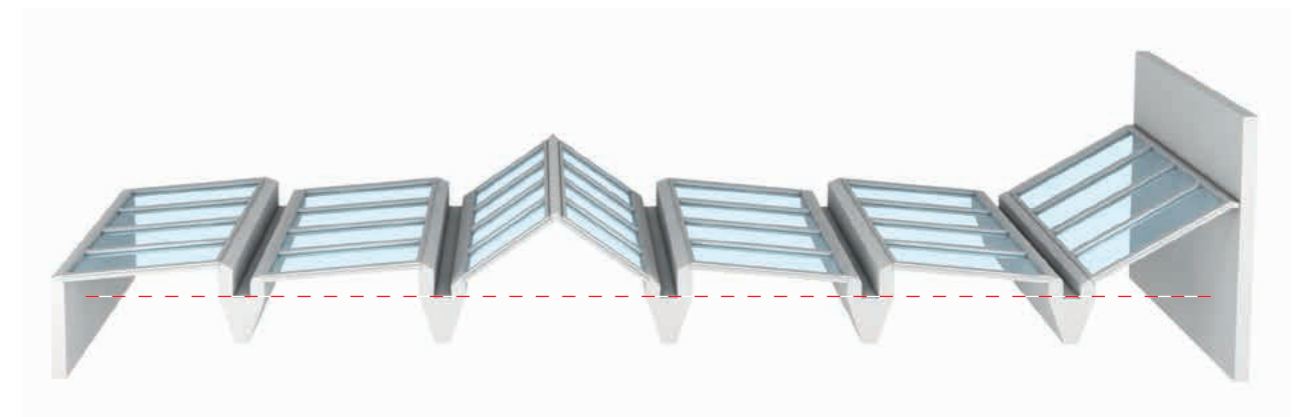

Feature	Advantage	Benefit
An atrium built of a combination of different solutions.	Combining different solutions in an installation exploits the advantages of each solution in one atrium and offers the possibility to optimize comfort and smoke ventilation areas.	Flexibility in designing an atrium.

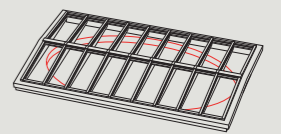

Infill Panel

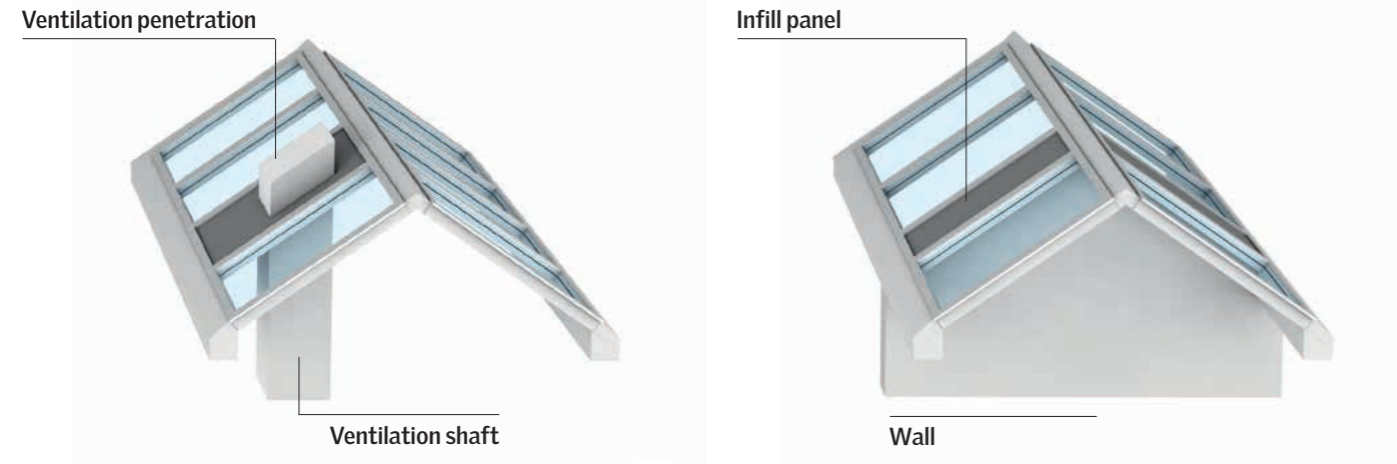

Feature	Advantage	Benefit
<p>Ventilation shaft: Use an infill panel when penetrating the skylight with e.g. ventilation.</p> <p>Wall: Use infill panels when covering a wall in the building.</p>	Continuous skylight installations instead of disrupted installations.	Cheaper product solution and better design.

Note:
Products with a fixed, opaque insulating infill panel are out of the scope of the harmonised product standard EN 14351-1 used for CE marking of windows. No harmonised product standard is available/applicable for these products; they are not and cannot be CE-marked. The VELUX Group can deliver the above-mentioned products and provide product specifications on the relevant general performance characteristics for thermal transmittance, air permeability, watertightness, resistance to wind load and reaction to fire, on request. The VELUX Group is not responsible for the specific application of the product with fixed, opaque insulating infill panel. It is the responsibility of the customer to verify the fitness of the product for specific use with the relevant authorities.

Skylight Modules with Photovoltaic Glazing Units

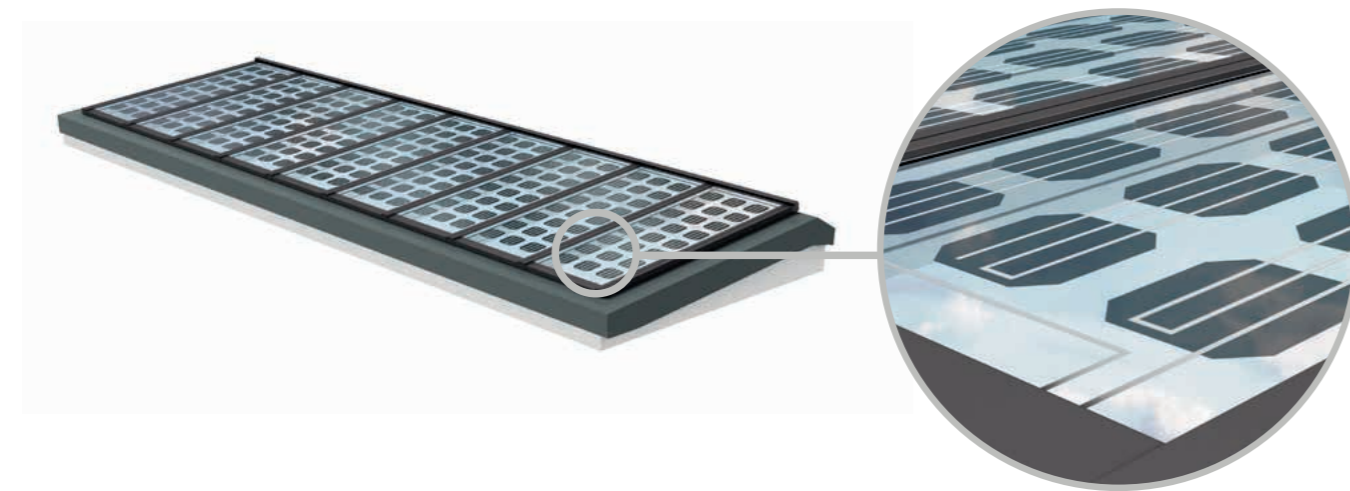

Feature	Advantage	Benefit
VELUX modular skylights can be delivered with photovoltaic glazing units in both a fully covered or partly covered variant (illustration shows partly covered variant).	The solution offers a build-in solution where photovoltaic panels are combined with skylights installations.	The solution will optimize the utilization of space on the roof. Further the photovoltaic panels creates a shadow effect in the building that reduces heat gain and glare.

Light Fittings on Modules

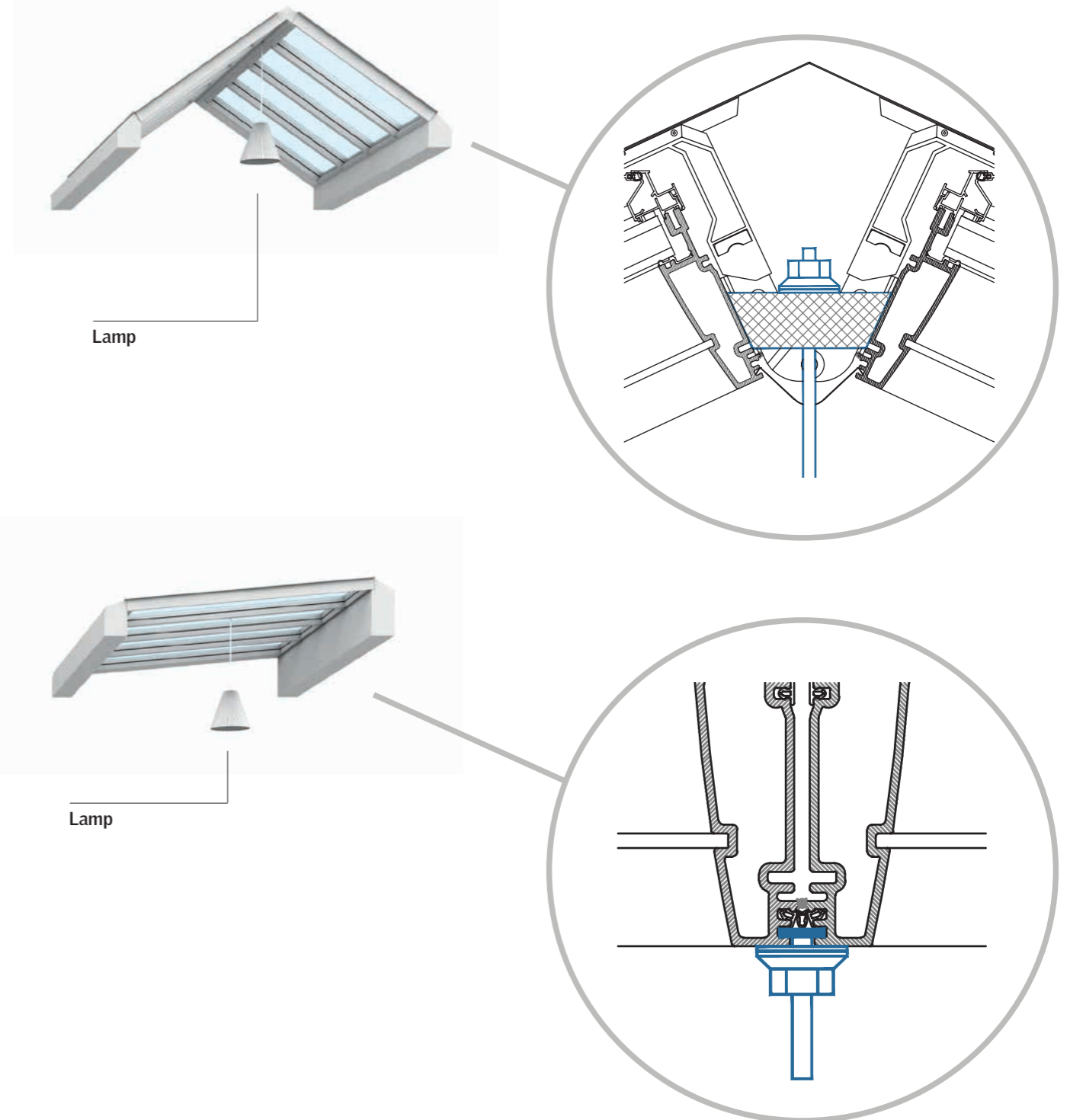

Feature	Advantage	Benefit
The inner ridge covering of a ridgetlight or the connection between two modules allows for mounting different kinds of functional or visual objects.	Use the inner ridge covering or the connection between modules to mount light fittings, smoke detectors, sprinklers etc.	Flexibility in mounting other functional products and features.

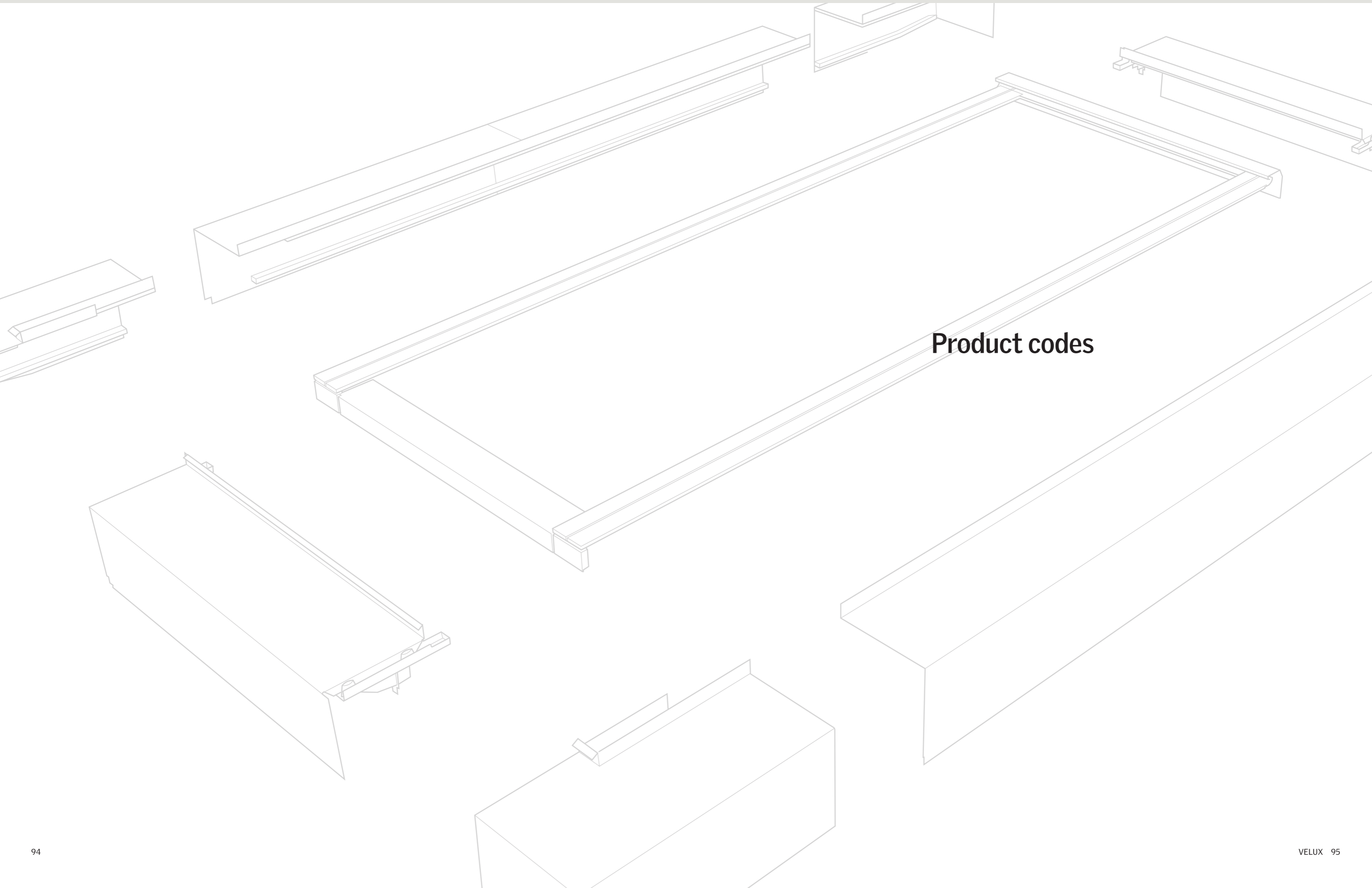

Product codes



Code Structure – Modular Skylights

Example

HVC	067	160	0	0	10	T	C	B
Type	Module width	Module height	Interior colour	Exterior colour	Pane type	Pane variant	Electric variant	Generation
H = VMS	067 = 675 mm	120 = 1200 mm	0 = std.	0 = std.	10 = DGU/LowE	No letter = 3+3 mm inner glass	No letter = VELUX INTE-GRA®	
	075 = 750 mm	140 = 1400 mm	RAL colour 9010, gloss 30	"Noir 2100 Sable YW" Akzo Nobel	11 = DGU/Sun1	T = 5+5 mm inner glass	A = Open-system / Smoke	
F = Fixed	080 = 800 mm	160 = 1600 mm			12 = DGU/Sun2			
V = Venting	090 = 900 mm	180 = 1800 mm			16 = TGU/LowE			
	100 = 1000 mm	200 = 2000 mm			17 = TGU/Sun1			
		220 = 2200 mm	8 = special		18 = TGU/Sun2	U = Fire resistant	C = Open-system / Comfort	
		240 = 2400 mm						
S = Fire-resistant variant. With fire resistant glazing unit and intumescent strip		260 = 2600 mm						
		280 = 2800 mm						
		300 = 3000 mm						

Code Structure – Opening flashing package

Code Structure – Module flashing package

Ridgelight 25-40°

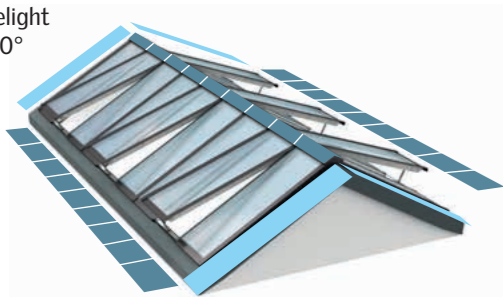

Ridgelight at 5° with Beam

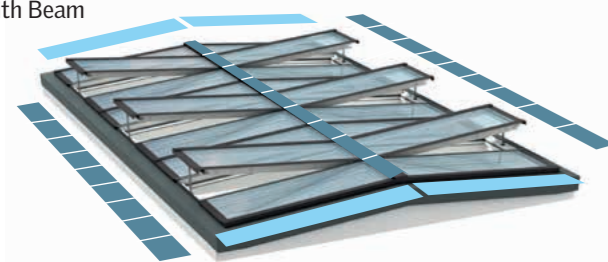

Longlight

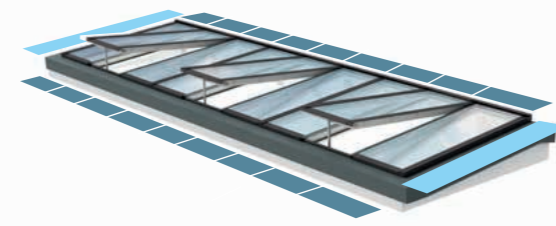

Wall mounted Longlight

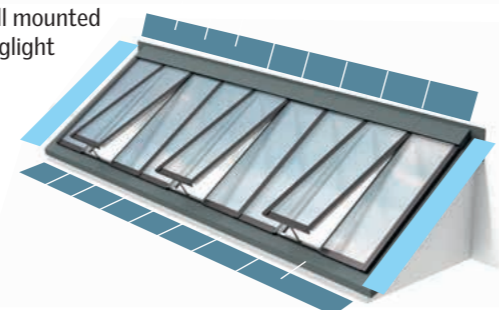

Northlight

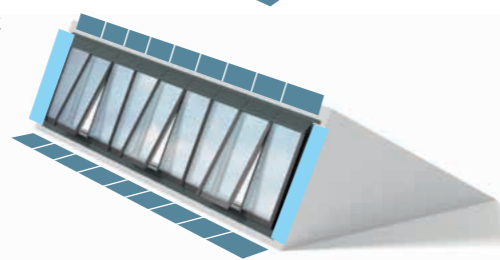

Code Structure – Opening flashing package

Example

ERC	XXX	160	0	0	0	25	D	B		
Type	Module width	Module height	Interior	Exterior Flashing	Exterior Cladding	Installation pitch	VMS Cover	Generation		
E = Flashing	XXX = Not relevant on height package	120 = 1200 mm	0 = std.	0 = std.	0 = std.	05 = 5°, 10 = 10° etc.	D = Extra cover			
		140 = 1400 mm	Only relevant on ERC: Beams	NCS standard colour: S 7500-N (RAL 7043)	"Noir 2100 Sable YW" Akzo Nobel	Standard pitches:				
L = Longlight		160 = 1600 mm				ELC	ERC	EWC	ENC	Extra Cover When HVC ≥ HFC
R = Ridgelight		180 = 1800 mm				05	05	05		
N = Northlight		200 = 2000 mm				10		10		
W = Wall-mounted Longlight		220 = 2200 mm				15		15		
		240 = 2400 mm				20		20		
		260 = 2600 mm				25	25	25		
C = Commercial Market		280 = 2800 mm						30	30	1 pcs for ELC/ EWC/ ENC
		300 = 3000 mm						35	35	
							40	40		
					25	2 pcs for ERC				
					55					

Code Structure – Module flashing package

Example

ERC	080	XXX	0	0	0	25	B		
Type	Module width	Module height	Interior	Exterior Flashing	Exterior Cladding	Installation pitch	Generation		
E = Flashing	067 = 675 mm	XXX = Not relevant on width package	0 = std.	0 = std.	0 = std.	05 = 5°, 10 = 10° etc.			
	075 = 750 mm		Only relevant on ERC: Inner ridge covering	RAL colour 9010	"Noir 2100 Sable YW" Akzo Nobel	Standard pitches:			
L = Longlight	080 = 800 mm					ELC	ERC	EWC	ENC
R = Ridgelight	090 = 900 mm					05	05	05	
N = Northlight	100 = 1000 mm					10		10	
W = Wall-mounted Longlight		15					15		
		20		20					
		25	25	25					
				30	30	1 pcs for ELC/ EWC/ ENC			
				35	35				
				40	40				
					25		2 pcs for ERC		
					55				

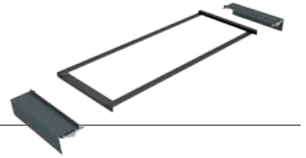

Product codes



Code Structure – Roller Blinds

Example

Type	Module width	Module height	Fabric variant	Electric variant
RMM	067	160	4083	A
R = Roller blind	067 = 675 mm	120 = 1200 mm	4083 = Grey	A = Open system
	075 = 750 mm	140 = 1400 mm	4084 = White	
M = Electrical	080 = 800 mm	160 = 1600 mm	4085 = Black	
	090 = 900 mm	180 = 1800 mm	4094 = Fire-resistant, white	
M = For VELUX Modular Skylights	100 = 1000 mm	200 = 2000 mm		
		220 = 2200 mm		
		240 = 2400 mm		
		260 = 2600 mm		
		280 = 2800 mm		
		300 = 3000 mm		

Code Structure – Product Label

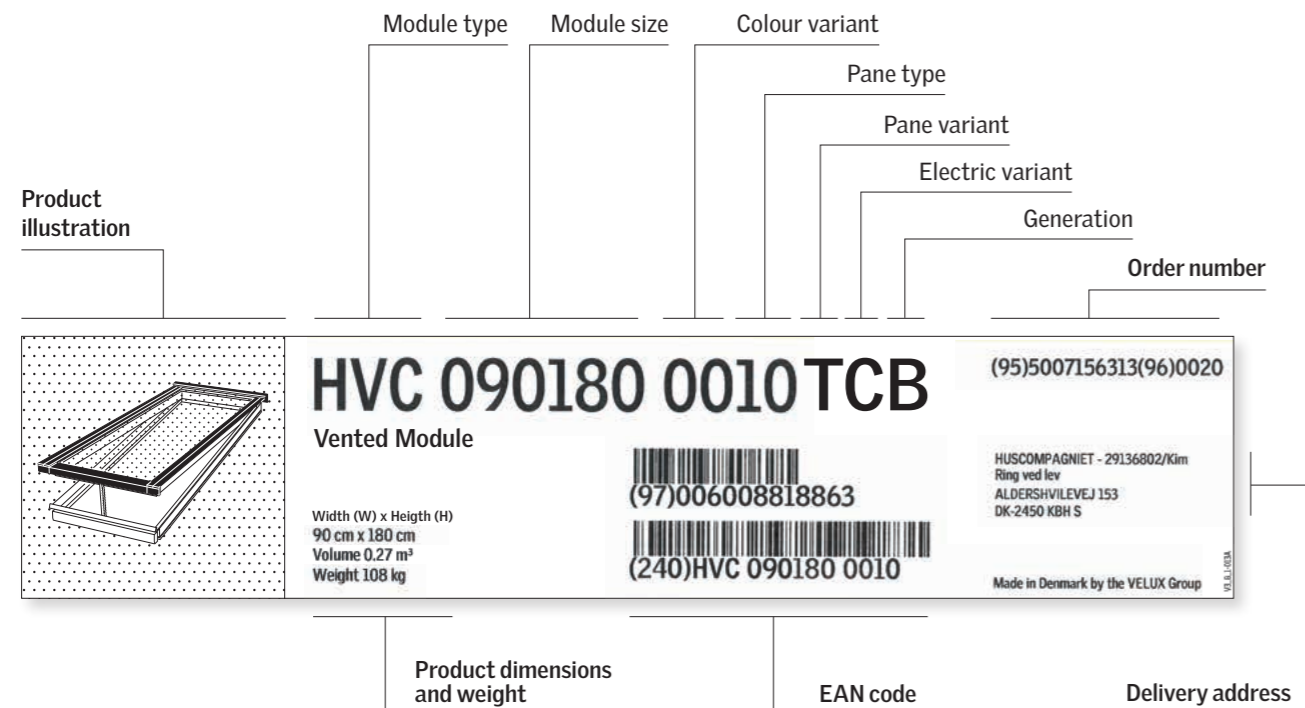

VELUX Company Ltd
Woodside Way
Glenrothes
Fife
KY7 4ND
Tel: 01592 778 916
Email: vms@velux.co.uk

Bringing light to life™

